



// ONE BRAND // ONE SOURCE // ONE SYSTEM



// SERVICE // MATERIAL PROCESSING // SURFACE PROTECTION // AUTOMOTIVE

REMA TIP TOP

Portfolio Tyre Repair Material 2016/2017



Portfolio Tyre Repair Material

Repair and sealing material for tyres and tubes	7-44
Special Tools for tyre repair	45-78
Tools for tyre handling/service	79-92
Vulcanizing machines and accessories	93-110
Valves, balance weights, accessories for tyre and wheel service, TPMS	111-116
Chemical products, safety at work	117-128
Index	129-133

Environmental protection and sustainability are the global challenges for us. Yesterday, today and tomorrow!

We specialize in the repair of all kinds of tires for bicycles, cars, trucks and motorcycles, up to and including OTR and EM tires. Repairs that have been professionally carried out permit both continued use of the tire, and, through retreading, create a second, if not a third, tire life. Our slogan "Don't replace it – maintain it" ensures that many millions of liters of crude oil and tons CO₂ are saved annually by not fitting new tires.



We could save more than **497.58 tons CO₂**, if each repairable tyre would be repaired.

497.58 tons



REMA TIP TOP bundles its company-wide **innovative power** in its global network and invests intensively and creatively in the development of new solutions based on the highest technological standards.

innovative power



Fundamental thinking concerning the ecology has left its mark on our business since the 1930s and "**repair instead of replacing**" is still the philosophy of the company.

"repair instead of replacing"

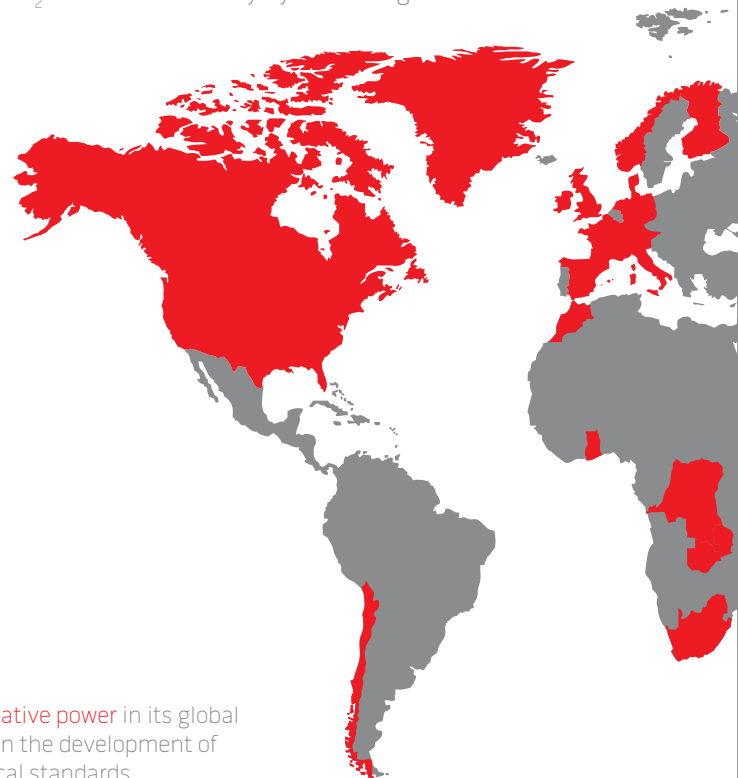



Our bicycle tyre repair kits make an active contribution to avoiding waste. Repair instead of replace means saving raw materials. One single bicycle tube has the same environmental impact as **16** REMA TIP TOP repair patches.

1/16



Our intelligent **TPMS systems** helps to prevent accidents, improve fuel economy and decrease carbon emissions.

TPMS



With its M-RCF repair system REMA TIP TOP is the only company in the world which offers a **100%** solvent free repair.

100%



Just taking into account the German market, we could save **329.5 million liters** of crude oil each year, by repairing tyres instead of replacing them. Imagine how much we could save globally!

329.5 million liters



Many millions of liters of crude oil are saved annually by not fitting new tyres.

Don't replace it – maintain it!



REPAIR AND SEALING MATERIAL FOR TYRES AND TUBES

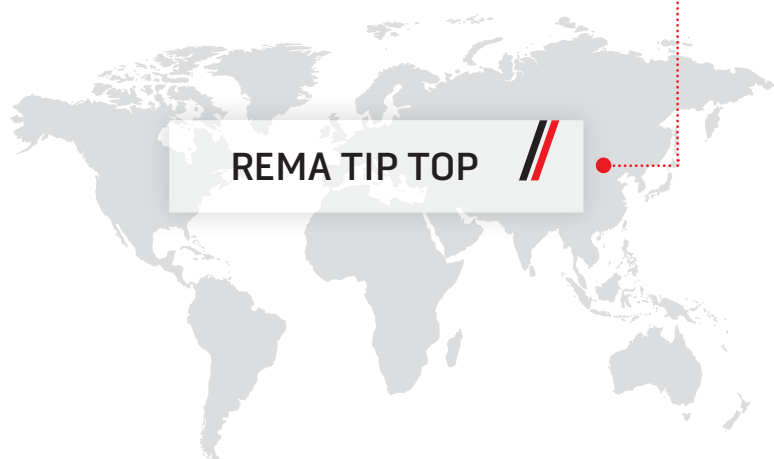

REMA TIP TOP



Sealants	8
Tube patches	9
Tube repair kits	10-12
Tube valves	13-14
Self vulcanizing systems	15-23
RADIAL repair patches	24-29
CROSS-PLY repair patches	30-31
Chemical cleaning	32
Vulcanizing fluids	33-36
Repair rubber	37-40
Supporting material	41-43

REPAIR AND SEALING MATERIAL FOR TYRES AND TUBES

Sealants

Preventive tyre sealant TT SEAL

- Preventive tyre sealant for tube-type and tubeless tyres
 - Helps to avoid costs arising from the breakdown of expensive vehicles and machines
 - Reduces the risk of tyre failures due to slow air loss, e.g. from smaller punctures
 - Automatically seals smaller injuries
 - Stays effective during the whole service life of a tyre
 - Affects neither existing tyre repairs nor the reparability of a tyre
 - Contains anti-corrosive agents for protection of rims and metal parts
 - Free of CFC and aromatic compounds
 - A detailed list of quantities required for each tyre sizes is enclosed
- Caution: Approved for a maximum speed of 80 km/h!**



593 2670

TT SEAL,
in display box

Ref. No.	Description	Content	Qty			
593 1239	TT SEAL, in display box	250 ml tube	12		•	•
593 1291	TT SEAL	250 ml tube	5		•	•
593 2670	TT SEAL	1000 ml bottle	10	•		•

Tyre sealant TT SEAL XXL

- The preventive tyre sealant for all pneumatic tyres
 - Avoids costly downtime of vehicles and equipment
 - Reduces the risk of slow air loss that often results from smaller punctures
 - Seals punctures up to eight mm
 - Easy introduction into mounted tyres
 - Effective during the whole service life of a tyre
 - Maintains the reparability of the tyre
 - A detailed list of quantities required for each tyre sizes is enclosed
- Caution: Approved for a maximum speed of 40 km/h!**



593 1252

593 1260

Ref. No.	Description	Content	Qty			
593 1252	TT SEAL XXL	20 l can	1		•	•
593 1260	TT SEAL XXL	60 l barrel	1		•	•
593 1277	TT SEAL hand pump XXL, 100 ml/stroke The suction tube is variable in length. Suitable for: TT SEAL XXL can 20 l; TT SEAL XXL barrel 60 l		1	1		
593 1284	TT SEAL valve adapter VG12 to VG8		1	1		



593 1277

593 1284

REPAIR AND SEALING MATERIAL FOR TYRES AND TUBES

Tube patches

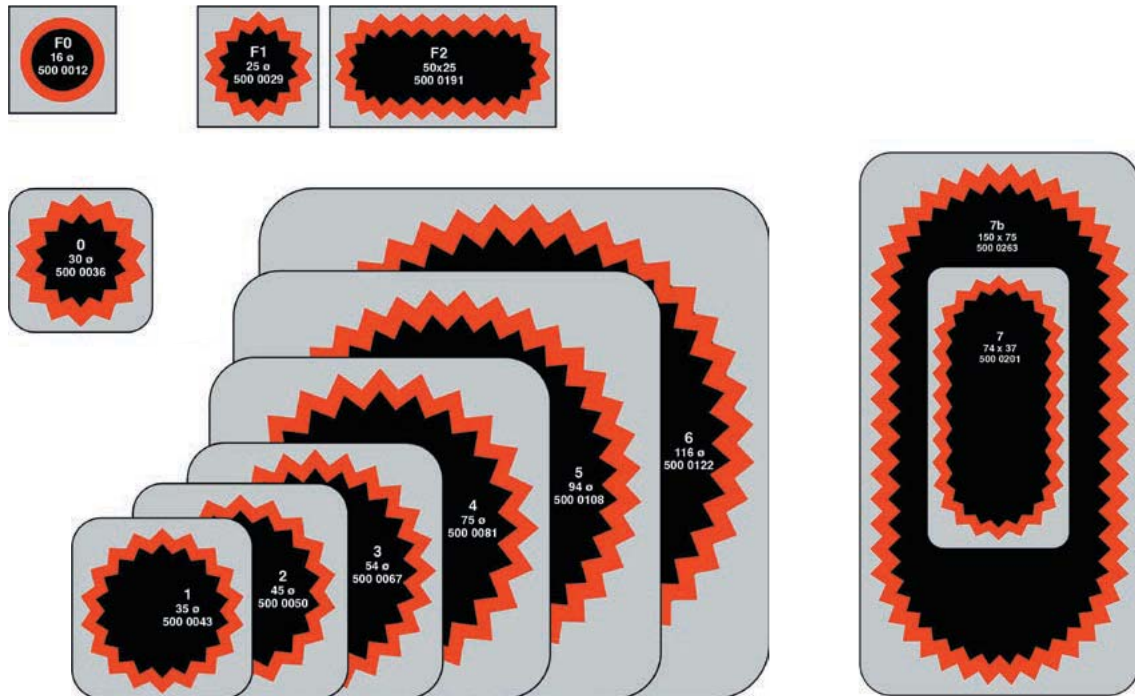

Tube patches, red edge

- REMA TIP TOP tube patches with double-scalloped edge applied with REMA TIP TOP SVS-VULC ensure perfect bonding through vulcanization
- Due to the stepped multi-layer structure of the tube patch body they stretch evenly in all directions when the tube is inflated
- They leave no edges on the repair area

Ref. No.	Description	Size	Content	Qty					
500 0012	Tube patches F 0, red edge	Ø 16 mm	100	1	•				
500 0029	Tube patches F 1, red edge	Ø 25 mm	100	1	•				
500 0191	Tube patches F 2, red edge	50 x 25 L x W mm	100	1	•				
500 0036	Tube patches No. 0, red edge	Ø 30 mm	100	1	•	•	•		
500 0043	Tube patches No. 1, red edge	Ø 35 mm	30	1	•	•	•		
500 0050	Tube patches No. 2, red edge	Ø 45 mm	30	1		•	•		
500 0067	Tube patches No. 3, red edge	Ø 54 mm	30	1			•	•	•
500 0081	Tube patches No. 4, red edge	Ø 75 mm	30	1			•	•	•
500 0108	Tube patches No. 5, red edge	Ø 94 mm	10	1				•	•
500 0122	Tube patches No. 6, red edge	Ø 116 mm	10	1				•	•
500 0201	Tube patches No. 7, red edge	74 x 37 L x W mm	30	1		•	•		
500 0263	Tube patches No. 7B, red edge	150 x 75 L x W mm	10	1				•	•

REPAIR AND SEALING MATERIAL FOR TYRES AND TUBES

Tube repair kits

Motorcycle repair kits TT 10

- Scope of delivery:**
- 4 Patches size 0
 - 1 Patch size F3
 - 1 Tube of SVS-VULC 5 g
 - 1 Emery paper
 - 1 Manual



Ref. No.	Description	Qty
506 0203	Motorcycle repair kit TT 10	24
506 4209	Motorcycle repair kit TT 10, with self-service clip	10



506 0203

Workshop kit TT 11

- Scope of delivery:**
- 6 Patches size 0
 - 1 Patch size F3
 - 1 Tube of SVS-VULC 5 g
 - 1 Emery paper
 - 1 Manual



Ref. No.	Description	Content	Qty
506 0306	Tube repair kit TT 11	1	24
506 4302	Tube repair kit TT 11, with self-service clip	1	40



506 0306

Workshop kit TT 12

- Scope of delivery:**
- 4 Patches size 1
 - 2 Patches size 2
 - 1 Patch size 3
 - 1 Patch size 4
 - 1 Patch size 7
 - 1 Patch size F3
 - 1 Tube of SVS-VULC 10 g
 - 1 Rasp
 - 1 Manual



Ref. No.	Description	Content	Qty
506 0519	Tube repair kit TT 12	1	10
506 4515	Tube repair kit TT 12, with self-service clip	1	20



506 0519

REPAIR AND SEALING MATERIAL FOR TYRES AND TUBES

Tube repair kits

Workshop kit TT 20

Scope of delivery:

- 8 Patches size 1
- 2 Patches size 2
- 1 Patch size 3
- 1 Patch size 4
- 1 Patch size 5
- 1 Patch size 7
- 2 Patches size F3
- 1 Patch size 7B
- 1 Tube of SVS-VULC 25 g
- 3 Rasps
- 3 Short valve cores
- 1 Manual



Ref. No.	Description	Content	Qty
506 0911	Tube repair kit TT 20	1	1



506 0911

Workshop kit TT 21

Scope of delivery:

- 14 Patches size 1
- 4 Patches size 2
- 2 Patches size 3
- 2 Patches size 4
- 1 Patch size 5
- 2 Patches size 7
- 4 Patches size F3
- 2 Patches size 7B
- 1 PN 03
- 1 Tube of SVS-VULC 50 g
- 5 Rasps
- 1 Rasp handle
- 3 Short valve cores
- 1 Stitcher
- 1 Manual



Ref. No.	Description	Content	Qty
507 0011	Tube repair kit TT 21	1	1



507 0011

Workshop kit TT 30

Scope of delivery:

- 12 Patches size 1
- 6 Patches size 3
- 2 Patches size 4
- 1 Patch size 5
- 3 Patches size F3
- 4 Patches size 7
- 2 Patches size 7B
- 2 PN 03
- 1 Tube of SVS-VULC 50 g
- 2 Rasps
- 1 Rasp handle
- 1 Stitcher
- 1 Manual



Ref. No.	Description	Content	Qty
507 0310	Tube repair kit TT 30	1	1



507 0310

REPAIR AND SEALING MATERIAL FOR TYRES AND TUBES

Tube repair kits

Workshop kit TT 40, tube

Scope of delivery:

- 70 Patches size 1
- 50 Patches size 2
- 40 Patches size 3
- 10 Patches size 4
- 30 Patches size F3
- 20 Patches size 7
- 5 Patches size 7B
- 1 Can of SVS-VULC 175 g
- 2 Rasps
- 1 Rasp handle
- 1 Stitcher
- 3 Rubber-based valve TR13
- 1 Manual



507 0602

Ref. No.	Description	Content	Qty
507 0602	Workshop kit TT 40	1	1

Workshop kit TT 42, tube

Scope of delivery:

- 100 Patches size 1
- 40 Patches size 2
- 20 Patches size 3
- 50 Patches size 7
- 30 Patches F2
- 1 Can of SVS-VULC 175 g
- 2 Rasps
- 1 Rasp handle
- 1 Stitcher
- 1 Can of LIQUID BUFFER 250 ml
- 1 Manual



507 9706

Ref. No.	Description	Content	Qty
507 9706	Workshop kit TT 42	1	1

REPAIR AND SEALING MATERIAL FOR TYRES AND TUBES

Tube valves



Rubber base valves



501 0088



501 0136



501 0143



501 0174



501 0277







501 0253



563 1900

Rubber base valves

Caution: Before doing repairs with valve patches and rubber base valves always buff the tube mechanically!

Ref. No.	Description	Rubber base dia.	Shaft dia.	Length	Bending angle	TR No.	Content	Qty				
501 0040	Moped valve	45 mm					10	1	•			
501 0088	Scooter valve	45 mm			90°		10	1	•			
501 0136	Car valve	60 mm	12 mm	38 mm		13	10	1		•		
501 0143	Car valve	60 mm	13.5 mm	38 mm		14	10	1		•		
501 0150	Car valve	60 mm	16.5 mm	38 mm		15	10	1		•		
501 0174	Car valve	80 mm	16.5 mm	52 mm		25	10	1		•		
501 0370	Truck valve	90 mm		125.5 mm		77a	5	1			•	
501 0394	Truck valve	90 mm		135.5 mm		175a	5	1			•	
501 0277	Air/water valve, new type	80 mm				218a	10	1				•
501 0253	Air/water valve, old type	80 mm				218	10	1				•
563 1900	Plastic rim ferrule for car valves						100	1		•		
501 0600	Special inner tube valve, retractable for floating hoses and sporting articles made of rubber						1	1				

REPAIR AND SEALING MATERIAL FOR TYRES AND TUBES

Tube valves



501 0545



501 0583



Valve patch, fabric reinforced



563 1948



562 8401



562 3224

Valve patches

Caution: Before doing repairs with valve patches and rubber base valves always buff the tube mechanically!

Ref. No.	Description	Rubber base dia.	Content	Qty	
501 0545	Truck valve seating for VG12	80 mm	10	1	•
501 0583	Truck valve seating for VG12	120 mm	5	1	•
501 0507	Truck valve seating for VG8 (Michelin)	80 mm	10	1	•
501 0521	Truck valve seating for VG8 (Michelin)	120 mm	5	1	•

Valve patches with fabric reinforcement

Caution: Before doing repairs with valve patches and rubber base valves always buff the tube mechanically!

Ref. No.	Description	Rim hole	Tube size	Content	Qty				
500 5718	Valve patch V1	7.5 mm	2.50 x 19 mm	10	1	•	•	•	
500 5725	Valve patch V2	7.5 mm	2.50 x 19 mm	10	1		•	•	
500 5732	Valve patch V3	7.5 mm	3.00 x 19 and 3.50 x 19 mm	10	1		•		
500 5749	Valve patch V4	7.5 mm	4.25 x 15 up to 7.00 x 20 mm	10	1			•	•
500 5756	Valve patch V5	7.5 mm	7.25 x 20 up to 7.50 x 20 mm	10	1				•
500 5763	Valve patch V6	7.5 mm	8.25 x 20 up to 14.00 x 20 mm	10	1				•

Rubber base valves (hot vulcanization)

Caution: Before doing repairs with valve patches and rubber base valves always buff the tube mechanically!

Ref. No.	Description	Alligator No.	ETRTO No.	TR No.	Content	Qty		
563 1948	Rubber base, with screw thread for VG8	32.7040			10	1	•	
562 8401	Adapter ring VG8/VG12				10	1	•	•
562 3224	Tractor valve			218a	10	1		•
562 2885	Rim nut, chromium		V9-14-1	LN 10	10	1		
562 2861	Rim nut, plastic			LN 10	10	1		

REPAIR AND SEALING MATERIAL FOR TYRES AND TUBES

Self vulcanizing systems

RUN-FLAT

For use with tread damage from 3 mm up to 4.5 mm.

- The RUN-FLAT REPAIR-KIT enables permanent repairs in the tread of car-tyres. Fits to car-tyres with inner sealing material or foam-rings for reduction of noise too
- The kit includes appropriate tools and products with special instructions for the safe repair of RUN-FLAT tyres

Scope of delivery:

- | | |
|---|---------------------------------|
| • 1 MINICOMBI A3 SET | • 1 Carbide mill cutter 3 mm |
| • 1 MINICOMBI A4.5 SET | • 1 Carbide mill cutter 4.5 mm |
| • 1 Can of LIQUID BUFFER 250 ml | • 1 Dome rasp K 60 |
| • 1 Can of INNERLINER SEALER 175 ml, with brush cover | • 1 Tool holder with 8 mm shaft |
| | • 1 Positioning template |
| | • 1 Instruction manual |



RUN-FLAT repair kit

Ref. No.	Description	Content	Qty
511 1190	RUN-FLAT repair kit	1	1

MINICOMBI - Overview

- Combined patch/plug tyre repair for punctures to the tread of both radial and cross-ply tyres
- Repair units self-vulcanize in the tyre
- The tyre inside and the puncture channel are repaired in one operation
- The ingression of moisture, dirt, stones or all materials that lead to premature deterioration of the casing and belts is prevented
- Available with a practical and time-saving metal pilot
- All MINICOMBI Combi Packs and workshop kits are supplied with CEMENT FD-BL

MINICOMBI A3/A6 SET

MINICOMBI A3/A6 SET combines the sets MINICOMBI A3 and MINICOMBI A6.

Scope of delivery:

- | | |
|-----------------------------|------------------------------------|
| • 25 Repair units A3 | • 1 HSS mill cutter Ø 6 mm |
| • 20 Repair units A6 | • 3 Tubes of CEMENT FD-BL 25g each |
| • 1 HSS steel cutter Ø 3 mm | • 1 Instruction manual |



511 2152

Ref. No.	Description	Content	Qty
511 2152	MINICOMBI A3/A6 SET	1	1

REPAIR AND SEALING MATERIAL FOR TYRES AND TUBES

Self vulcanizing systems

MINICOMBI A6/B8 SET

MINICOMBI A6/B8 SET combines the sets MINICOMBI A6 and MINICOMBI B8.

Scope of delivery:

- 20 Repair units A6
- 20 Repair units B8
- 1 HSS mill cutter \varnothing 6 mm
- 1 HSS mill cutter \varnothing 8 mm
- 4 Tubes of CEMENT FD-BL 25 g each
- 1 Instruction manual



Ref. No.	Description	Content	Qty
511 2200	MINICOMBI A6/B6 SET	1	1



511 2200

MINICOMBI A3

For use with tread damage up to 3 mm.

Scope of delivery (Set):

- 25 Repair units A3
- 1 HSS steel cutter \varnothing 3 mm
- 2 Tubes of CEMENT FD-BL 25 g each
- 1 Instruction manual



Ref. No.	Description	Content	Qty
511 1957	MINICOMBI A3 SET	1	1
511 1964	MINICOMBI A3 P, refill pack includes 50x Repair units A3 with metal pilot, 1x Instruction manual	50	1



511 1957



511 1964

MINICOMBI A4.5

For use with tread damage up to 4.5 mm.

Scope of delivery (Set):

- 20 Repair units A4.5
- 1 HSS mill cutter \varnothing 4.5 mm
- 2 Tubes of CEMENT FD-BL 25 g each
- 1 Instruction manual



Ref. No.	Description	Content	Qty
511 3209	MINICOMBI A4.5 SET	1	1
511 3216	MINICOMBI A4.5 P, refill pack includes 40x Repair units A4.5 with metal pilot, 1x Instruction manual	40	1



511 3209



511 3216

REPAIR AND SEALING MATERIAL FOR TYRES AND TUBES

Self vulcanizing systems

MINICOMBI A6

For use with tread damage up to 6 mm.

- Scope of delivery (Set):**
- 20 Repair units A6
 - 1 HSS mill cutter \varnothing 6 mm
 - 2 Tubes of CEMENT FD-BL
 - 1 Instruction manual



511 3041

Ref. No.	Description	Content	Qty
511 3041	MINICOMBI A6 SET	1	1
511 3058	MINICOMBI A6 P, refill pack includes 40x Repair units A6 with metal pilot, 1x Instruction manual	40	1
511 3072	MINICOMBI A6, refill pack includes 40x Repair units A6 without metal pilot, 6x Pull wires, 1x Instruction manual	40	1



511 3058



511 3072

MINICOMBI B8

For use with tread damage up to 8 mm.

- Scope of delivery (Set):**
- 20 Repair units B8
 - 1 HSS mill cutter \varnothing 8 mm
 - 2 Tubes of CEMENT FD-BL
 - 1 Instruction manual



511 3096

Ref. No.	Description	Content	Qty
511 3096	MINICOMBI B8 SET	1	1
511 3106	MINICOMBI B8 P, refill pack includes 20x Repair units B8 with metal pilot, 1x Instruction manual	20	1
511 3128	MINICOMBI B8, refill pack includes 20x Repair units B8 without metal pilot, 3x Pull wires, 1x Instruction manual	20	1



511 3106

REPAIR AND SEALING MATERIAL FOR TYRES AND TUBES

Self vulcanizing systems



511 3137



511 1808



510 1155

510 2147

510 2161

MINICOMBI B10

For use with tread damage up to 10 mm.

Ref. No.	Description	Content	Qty			
511 3144	MINICOMBI B10 P, refill pack includes 20x Repair units B10 with metal pilot, 1x Instruction manual	20	1	•	•	•
511 3137	MINICOMBI B10, refill pack includes 20x Repair units B10 without metal pilot, 3x Pull wires, 1x Instruction manual	20	1	•	•	•

Accessories - MINICOMBI

Ref. No.	Description	Content	Qty
511 1808	Pull wire	1	1
581 1710	Repair instruction, MINICOMBI Repair chart valid at the moment of printing. Always refer to the repair chart and safety advice packed with the product!	1	1

SEALASTIC

- Temporary nail hole fast sealing for cross-ply truck tyres mounted on the rim (max. injury size 8 mm) as well as EM and agricultural tyres (max. injury size 15 mm)
- Also suitable for tubeless radial EM tyres (up to a maximum speed of 40 km/h, if a carbide mill cutter is used to cut out steel wires in the channel of the damage)

- For larger injuries, use the corresponding REMA TIP TOP repair patches according to the relevant repair chart

Scope of delivery (Kit):

- 10 Sealing units
- 2 CEMENT SC-BL 40 g cans

- 1 Insertion tool for EM
- 1 Rasp Ø 6.5 mm
- 1 Manual

REPAIR AND SEALING MATERIAL FOR TYRES AND TUBES

Self vulcanizing systems

Ref. No.	Description	Content	Qty			
510 1155	SEALASTIC EM, kit	1	1	•	•	•
510 2147	SEALASTIC TT 611, refill pack	20	1			•
510 2161	SEALASTIC TT 612, refill pack	20	1		•	

SUPER SL TT 650

- Multi-layer sealing units for temporary fast sealing of mounted cross-ply tyres

- For a permanent repair, use the REMA TIP TOP patches corresponding to the valid repair chart

Scope of delivery (Kit):

- 50 Sealing units
- 2 CEMENT SC-BL 40 g cans
- 1 Chalk
- 1 Clasp knife
- 1 Inserting tool car/truck
- 1 Manual



510 3304

Ref. No.	Description	Content	Qty	
510 3304	SUPER SL TT 650, workshop kit	1	1	•
510 3108	SUPER SL TT 660, refill pack	50	1	•

SUPER SL TT 651

- Multi-layer sealing units for temporary fast sealing of mounted cross-ply tyres

- For a permanent repair, use the REMA TIP TOP patches corresponding to the valid repair chart

Scope of delivery:

- 5 Sealing units
- 1 CEMENT SC-BL 12 g tube (CFC-free)
- 1 Chalk
- 1 Knife with plastic handle
- 1 Inserting tool car
- 1 Manual



510 3407

Ref. No.	Description	Content	Qty	
510 3407	SUPER SL TT 651, drivers kit	6	1	•

REPAIR AND SEALING MATERIAL FOR TYRES AND TUBES

Self vulcanizing systems



510 1849

510 1801

510 2202

510 2219

510 2233

595 5002

Accessories - SEALASTIC and SUPER SL

For precise injury preparation.

Ref. No.	Description	Length mm	Dia. mm	Blade length	Speed	Content	Qty					
510 2202	Inserting tool, with folding handle Suitable for: RAS, SRAS, SUPER SL					1	1	•	•			
510 2219	Inserting tool for car tyres, with plastic handle	approx. 72				1	1		•			
510 2226	Inserting tool for truck tyres, with plastic handle	approx. 96				1	1			•		
510 2233	Inserting tool EM, with plastic handle	approx. 230				1	1				•	•
595 8944	Rasp	195	6.5			1	1					
595 5002	HM mill cutter, pointed (extra long) Suitable for: SEALASTIC EM preparation of injuries using a hand drill Arbour for hand drill: fixed shaft 10 mm Arbour for quick release chuck: 519 6593 Arbour MK 1 for flexible shaft: 595 4027 with 519 6593	250	9.5	60 mm	max. 2500 rpm	1	1				•	•

SEALFIX GO-ON

- SEALFIX strings for temporary sealing of tread punctures
- We recommend demounting the tyre from the rim in order to determine the actual damage size
- Observe local rules and guidelines for the repair of tyres

- Permanent repairs should be performed from the inside of the tyre, for example with MINICOMBI
- For safety reasons, we also warn you not to carry out sidewall injuries with SEALFIX
- Please use it with CEMENT SC-BL

Scope of delivery (Kit):

- 5 Strings
- 1 CEMENT SC-BL 12 g tube
- 1 Hand rasp
- 1 Inserting tool
- 1 Manual

Ref. No.	Description	Length	Dia.	Content	Qty	
510 1849	SEALFIX GO-ON	approx. 100 mm	approx. 6 mm	1	1	•
510 1856	SEALFIX 5, refill pack			5	1	•
510 1801	SEALFIX 50, refill pack			50	1	•

REPAIR AND SEALING MATERIAL FOR TYRES AND TUBES

Self vulcanizing systems



510 1832



510 1863



510 1818



510 2408



510 2415

SEALFIX SHOP, workshop kit

- SEALFIX strings for temporary sealing of tread punctures
- We recommend demounting the tyre from the rim in order to determine the actual damage size
- Observe local rules and guidelines for the repair of tyres
- Permanent repairs should be performed from the inside of the tyre, for example with MINICOMBI

- For safety reasons, we also warn you not to carry out sidewall injuries with SEALFIX
- Please use it with CEMENT SC-BL

Scope of delivery (Kit):

- 25 Strings
- 1 CEMENT SC-BL 40 g can
- 1 Hand rasp

- 1 Inserting tool
- 1 Chalk
- 1 Knife
- 1 Manual

Ref. No.	Description	Length	Dia.	Content	Qty			
510 1832	SEALFIX SHOP, workshop kit	approx. 200 mm	approx. 6 mm	1	1	•	•	•
510 1863	SEALFIX 25, refill pack			25	1	•		

Accessories - SEALFIX

Ref. No.	Description	Content	Qty			
510 1818	Inserting tool	1	1			
510 1825	Spare needle	1	1			
510 2381	Inserting tool car, 4"	1	1	•		
510 2398	Inserting tool truck, 6"	1	1		•	
510 2408	Inserting tool OTR/EM, 8"	1	1			•
510 2415	Tool kit, metal includes 1x Inserting tool, 1x Rasp, 1x Allan key	1	1	•		

REPAIR AND SEALING MATERIAL FOR TYRES AND TUBES

Self vulcanizing systems

RADIAL ANCHOR SEAL (RAS)

- This sealing system is used for a temporary sealing without demounting the wheel
- Quick sealing on the road
- No demounting of tyre - sealing from outside
- Supplied in a convenient plastic box
- Includes all tools required
- Comes with detailed instructions
- This sealing system enables the driver to carefully continue the journey at a maximum speed of 80 km/h, until the tyre can be repaired professionally and permanently.

Scope of delivery:

- 25 Super Sealastic plugs
- 1 Tin of CEMENT SC-BL 70 g
- 1 Tin of CEMENT SC-BL 40 g
- 1 Hand rasp with plastic handle
- 1 Knife with plastic handle
- 1 Folding insert tool
- 1 Oil marking chalk, white
- 1 Manual



510 3500

Ref. No.	Description	Content	Qty		
510 3500	RAS Emergency kit	1	1	•	•

PLUG SRAS-PROFI (SUPER RADIAL ANCHOR SEAL)

- The SUPER RADIAL ANCHOR SEAL (SRAS) sealing system from REMA TIP TOP is used for a temporary sealing on the spot
- No need to demount the wheel
- Perfect sealing by cold vulcanization
- Quick sealing on the road
- Available as a kit including tools
- This sealing system allows continued driving with caution until a permanent repair, e.g. with REMA TIP TOP Minicombi, can be carried out

Scope of delivery (Kit):

- 40 Sealing plugs
- 2 Tin of CEMENT SC-BL 40 g
- 1 Rotary cutter 6 mm to use with cordless screwdrivers
- 1 Hand rasp with plastic handle
- 40 Stickers (max. 80 km/h - 50 mph)
- 1 Chalk holder
- 1 Folding insert tool
- 1 Chalk
- 1 Knife
- 1 Manual



510 3610

Ref. No.	Description	Content	Qty		
510 3610	SRAS-PROFI	1	1	•	•
510 3710	SRAS-REFILL	40	1	•	•



510 3710

REPAIR AND SEALING MATERIAL FOR TYRES AND TUBES

Self vulcanizing systems



510 1540



510 2202



REMASEM



510 2240

Accessories - RAS and SRAS

Ref. No.	Description	Content	Qty			
510 1540	Hand ratchet for 6 mm milling cutter	1	1	•	•	•
510 2202	Inserting tool, with folding handle Suitable for: RAS; SRAS; SUPER-SL	1	1	•	•	
510 2240	Hand rasp Ø 6 mm	1	1	•	•	

REMASEM

- Rubber insert used to fill cylindrical puncture channels in the tread area
- REMASEM units are precured rubber plugs which can be used only together with the corresponding REMA TIP TOP patches
- To select the appropriate patch size, refer to the valid repair charts
- REMASEM is suitable for hot and cold vulcanization

Ref. No.	Description	Injury	Content	Qty			
510 1935	REMASEM 6	max. 6 mm	60	1	•	•	•
510 1942	REMASEM 8	max. 8 mm	60	1	•	•	
510 1928	REMASEM 10	max. 10 mm	20	1	•	•	
510 1959	REMASEM 12	max. 12 mm	20	1	•	•	

REPAIR AND SEALING MATERIAL FOR TYRES AND TUBES

RADIAL repair patches



UNIVERSAL PATCH (UP)





UNIVERSAL PATCH (UP)

Universal patches (UP) for the repair of small injuries to tube or tubeless radial and cross-ply tyres.

Ref. No.	Description	Size	Content	Qty		
512 5020	UNIVERSAL PATCH UP 3	Ø 27 mm	100	1	•	•
512 5030	UNIVERSAL PATCH UP 3, bucket	Ø 27 mm	550	1	•	•
512 5040	UNIVERSAL PATCH UP 4.5	Ø 37 mm	100	1	•	•
512 5050	UNIVERSAL PATCH UP 4.5, bucket	Ø 37 mm	300	1	•	•
512 5060	UNIVERSAL PATCH UP 6	Ø 43 mm	50	1	•	•
512 5070	UNIVERSAL PATCH UP 6, bucket	Ø 43 mm	350	1	•	•
512 5080	UNIVERSAL PATCH UP 8	Ø 55 mm	50	1	•	
512 5090	UNIVERSAL PATCH UP 8, bucket	Ø 55 mm	200	1	•	
512 5100	UNIVERSAL PATCH UP 10	Ø 63 mm	50	1	•	
512 5110	UNIVERSAL PATCH UP 10, bucket	Ø 63 mm	150	1	•	
512 5120	UNIVERSAL PATCH UP 12	Ø 63 mm	30	1	•	
512 5130	UNIVERSAL PATCH UP 12, bucket	Ø 63 mm	150	1	•	

RAD repair patches, series 100

Repair patches for durable repairs to all radial tyres. Suitable for hot- or self-vulcanization.

Ref. No.	Description	Number of plies	Size	Content	Qty					
512 1104	RAD repair patch 110 TL	1	75 x 55 L x W mm	20	1	•				
512 1120	RAD repair patch 112 TL	1	115 x 70 L x W mm	10	1	•				
512 1140	RAD repair patch 114 TL	1	130 x 85 L x W mm	10	1	•				
512 1159	RAD repair patch 115 TL	1	90 x 75 L x W mm	20	1	•	•	•		
512 1160	RAD repair patch 116 TL	1	104 x 67 L x W mm	10	1	•	•	•		
512 1207	RAD repair patch 120 TL	2	125 x 80 L x W mm	10	1		•	•	•	
512 1221	RAD repair patch 122 TL	2	175 x 75 L x W mm	10	1		•	•	•	

REPAIR AND SEALING MATERIAL FOR TYRES AND TUBES

RADIAL repair patches

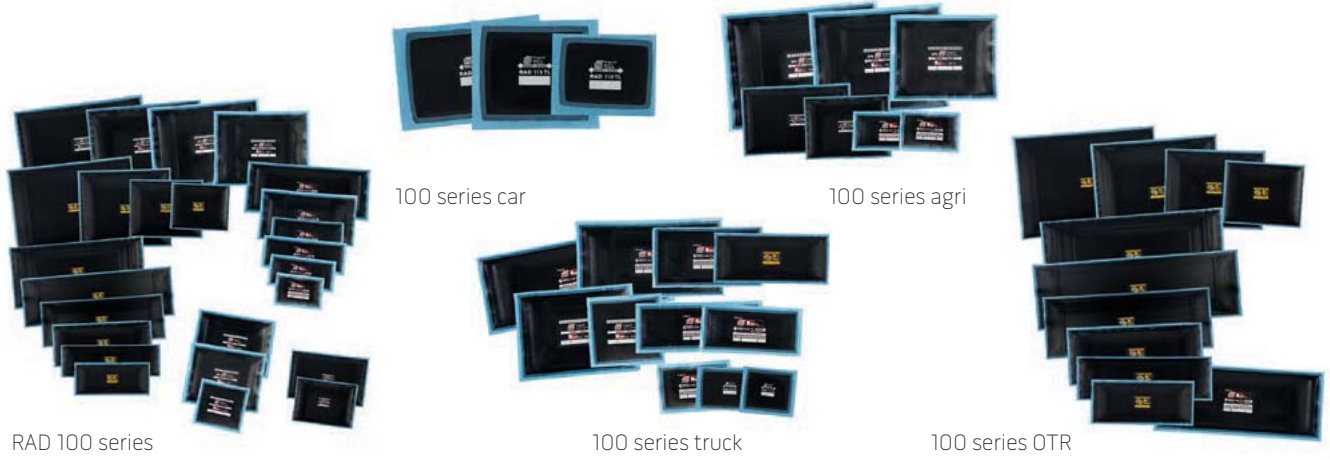

Ref. No.	Description	Number of plies	Size	Content	Qty					
512 1245	RAD repair patch 124 TL	2	220 x 75 L x W mm	10	1			•		
512 1252	RAD repair patch 125 TL	3	125 x 115 L x W mm	10	1			•		
512 1269	RAD repair patch 126 TL	3	260 x 75 L x W mm	10	1			•		
512 1283	RAD repair patch 128 TL	3	330 x 75 L x W mm	10	1			•		
512 1360	RAD repair patch 135 TL	4	203 x 148 L x W mm	10	1		•	•		•
512 1403	RAD repair patch 140 TL	3	195 x 100 L x W mm	10	1		•	•		
512 1427	RAD repair patch 142 TL	4	260 x 130 L x W mm	10	1		•	•		
512 1441	RAD repair patch 144 TL	4	335 x 130 L x W mm	10	1			•		•
512 1465	RAD repair patch 146 TL	4	440 x 180 L x W mm	5	1			•		•
512 1506	RAD repair patch 150 TL	5	580 x 180 L x W mm	5	1					•
512 1520	RAD repair patch 152 TL	5	580 x 240 L x W mm	3	1					•
512 1551	RAD repair patch 155 TL	5	330 x 260 L x W mm	5	1					•
512 1568	RAD repair patch 156 TL	7	720 x 270 L x W mm	3	1					•
512 1609	RAD repair patch 160 TL	7	860 x 270 L x W mm	3	1					•
512 1623	RAD repair patch 162 TL	7	1030 x 325 L x W mm	1	1					•
512 1654	RAD repair patch 165 TL	6	420 x 330 L x W mm	3	1					•
512 1685	RAD repair patch 168 TL	7	760 x 350 L x W mm	1	1					•
512 1757	RAD repair patch 175 TL	8	530 x 450 L x W mm	3	1					•
512 1805	RAD repair patch 180 TL	2	190 x 150 L x W mm	5	1			•		
512 1829	RAD repair patch 182 TL	3	240 x 185 L x W mm	5	1			•		
512 1843	RAD repair patch 184 TL	3	295 x 215 L x W mm	5	1			•		
512 1852	RAD repair patch 185 TL	8	730 x 530 L x W mm	1	1					•
512 1867	RAD repair patch 186 TL	2	340 x 245 L x W mm	5	1			•		
512 1881	RAD repair patch 188 TL	2	450 x 280 L x W mm	5	1			•		
512 1908	RAD repair patch 190 TL	2	550 x 310 L x W mm	3	1			•		

REPAIR AND SEALING MATERIAL FOR TYRES AND TUBES RADIAL repair patches

RAD repair patches, series 100 - Preventive

- EM patch, specially designed for non-penetrating damage.
- For tyre sizes from 51" to 63"

Note: Prevent repair patches may not be used for damage to the casing.

Ref. No.	Description	Content	Qty	
512 1652	RAD repair patch 165 TL Prevent	3	1	•
5121752	RAD repair patch 175 TL Prevent	3	1	•
5121853	RAD repair patch 185 TL Prevent	1	1	•

RAD repair patches, series 300 – STEEL

- Real tyre steel-cord as reinforcing ply
- Replaces defective steel-cord in the truck carcass with identic performance data
- Optimized construction against bulging by sidewall injuries
- Slim patchcast for an easy installation process s and improved adaptability to the inner tyre contour

300 series STEEL



Ref. No.	Description	Abmessungen	Content	Qty	
512 9310	RAD 331 STEEL	165 x 75 mm	10	1	•
512 9330	RAD 333 STEEL	205 x 90 mm	10	1	•
512 9350	RAD 335 STEEL	245 x 95 mm	10	1	•
512 9370	RAD 337 STEEL	285 x 100 mm	10	1	•
512 9390	RAD 339 STEEL	325 x 105 mm	10	1	•
512 9410	RAD 341 STEEL	365 x 110 mm	10	1	•
512 9430	RAD 343 STEEL	445 x 120 mm	5	1	•

REPAIR AND SEALING MATERIAL FOR TYRES AND TUBES

RADIAL repair patches

M-RCF repair patches, series 400

- Repair patches for durable repairs to radial car and truck tyres
- Cementless application with extra high green-tack
- Pre-warming of the patch to 60°C before installation substitutes the application of vulcanizing cement inside the tyre
- Modular construction = less sizes for a wide coverage of damages
- Specialized for one-step vulcanization process in retreading, or mold-systems
- When used inside ARC system (without inner cover), apply RCF SEALER PLUS before vulcanization
- Application with retreading cement possible, no pre-warming of the patch necessary

M-RCF repair patches, series 400



Ref. No.	Description	Number of plies	Size	Content			
512 3100	M-RCF 410	1	83 x 60 mm L x B	20	•		
512 3200	M-RCF 420	1	124 x 80 mm L x B	10	•	•	•
512 3210	M-RCF 420 +	2	124 x 80 mm L x B	10		•	•
512 3240	M-RCF 424	2	220 x 80 mm L x B	10		•	
512 3250	M-RCF 425 +	3	133 x 122 mm L x B	10		•	
512 3270	M-RCF 426	3	270 x 80 mm L x B	10		•	
512 3400	M-RCF 440	2	200 x 110 mm L x B	10		•	•
512 3410	M-RCF 440 +	3	200 x 110 mm L x B	10		•	•
512 3420	M-RCF 442	3	270 x 140 mm L x B	10		•	•
512 3430	M-RCF 442 +	4	270 x 140 mm L x B	10		•	•

Accessories - RCF (Repairs Customer Friendly)

Ref. No.	Description	Content	Qty
517 3260	RCF System-Box, 230 V	1	1
517 3270	RCF System-Box, 115 V	1	1
515 9091	RCF SEALER-PLUS,	1	1
593 2010	RCF FAST DRY BUFFER	1	1
595 8380	RCF rotary brush	1	1
595 4330	Dome rasp K 36, gold class	1	1
595 4656	Dome rasp K 36, silver class	1	1



517 3260, 517 3270



595 8380 593 2010 515 9091



595 4330 595 4656

REPAIR AND SEALING MATERIAL FOR TYRES AND TUBES

RADIAL repair patches





500 series truck



500 series agri

RAD repair patches, series 500 - ARAMID

- The repair patch for professional repairs
- Aramid-reinforced patch construction ensures a long service life
- Low bulge factor
- Low weight and high flexibility
- Perfectly suits the tyre contour as well as the rolling behaviour of the new-generation tyres

Ref. No.	Description	Size	Content	Qty		
512 5314	RAD repair patch 531, ARAMID	165 x 75 L x W mm	10	1	•	
512 5338	RAD repair patch 533, ARAMID	205 x 90 L x W mm	10	1	•	
512 5352	RAD repair patch 535, ARAMID	245 x 95 L x W mm	10	1	•	
512 5376	RAD repair patch 537, ARAMID	285 x 100 L x W mm	10	1	•	
512 5390	RAD repair patch 539, ARAMID	325 x 105 L x W mm	10	1	•	
512 5410	RAD repair patch 541, ARAMID	365 x 110 L x W mm	10	1	•	
512 5431	RAD repair patch 543, ARAMID	445 x 120 L x W mm	5	1	•	
512 5810	RAD repair patch 581, ARAMID	195 x 155 L x W mm	5	1		•
512 5830	RAD repair patch 583, ARAMID	245 x 190 L x W mm	5	1		•
512 5850	RAD repair patch 585, ARAMID	350 x 220 L x W mm	5	1		•
512 5870	RAD repair patch 587, ARAMID	450 x 280 L x W mm	5	1		•
512 5890	RAD repair patch 589, ARAMID	590 x 330 L x W mm	3	1		•

REPAIR AND SEALING MATERIAL FOR TYRES AND TUBES

RADIAL repair patches



Thermopress fast-curing repair patches

- For repairing nail hole injuries to radial or cross-ply car tyres as well as ATV/quad bike tyres
- The patches have to be applied with SOLUTION MTR
- Minimum curing temperature: 100 °C (212 °F)
- The sizes 100 - 103 are also suitable for hot vulcanization of tubes

Ref. No.	Description	Size	Content	Qty
517 1006	Thermopress patch No. 100	Ø 30 mm	80	1
517 1020	Thermopress patch No. 102	Ø 37 mm	50	1
517 1037	Thermopress patch No. 103	Ø 47 mm	35	1
517 1707	Thermopress patch No. 170, CROSS-PLY	Ø 70 mm	20	1
517 1817	Thermopress patch No. 181, RADIAL	65 x 55 mm	20	1

Thermopress tyre repair kit

Basic equipment with tools and repair products for fast tyre repairs.

Scope of delivery:

- 516 1243 1 MTR RUBBER, 2500 x 150 x 0.8 mm
- 517 1006 80 Thermopress patches no. 100, Ø 30 mm
- 517 1020 50 Thermopress patches no. 102, Ø 37 mm
- 517 1037 35 Thermopress patches no. 103, Ø 47 mm
- 517 1817 20 Thermopress patches no. 181 (RADIAL), 65 x 55 mm
- 511 3041 MINICOMBI A6 SET
- 516 9207 1 Can of SOLUTION MTR (350 g) with brush top
- 595 2971 2 Car tyre spreaders
- 596 1027 1 Roller sticher, standard, corrugated
- 595 0076 1 Rotary wire brush Ø 60 mm x 20 mm
- 595 4034 1 Arbour, 3/8"
- 595 4216 1 Dome rasp K36, Ø 65 mm
- 1 Instruction manual

Ref. No.	Description	Content	Qty	
517 3822	THERMOPRESS SET, carrying case	1	1	•





REPAIR AND SEALING MATERIAL FOR TYRES AND TUBES

CROSS-PLY repair patches



CROSS-PLY repair patches, series PN

- Repair patches for durable repairs to cross-ply tyres of all sizes, especially for tread, shoulder and sidewall injuries
- Suitable for both self-vulcanizing and hot-vulcanizing processes due to the fully integrated bonding layer. Use in conjunction with the appropriate REMA TIP TOP accelerator solutions

Ref. No.	Description	Patch Ø in cord direction	Number of plies	Content	Qty				
5125251	CROSS-PLY repair patch FRU 1	55 mm	1	30	1	•	•		
5125261	CROSS-PLY repair patch FRU 2	77 mm	1	30	1	•	•		
512 6037	CROSS-PLY repair patch PN 03	100 mm	2	10	1	•	•		
512 6044	CROSS-PLY repair patch PN 04	120 mm	2	10	1	•	•		
512 6051	CROSS-PLY repair patch PN 05	160 mm	4	10	1	•			
512 6068	CROSS-PLY repair patch PN 06	235 mm	6	10	1	•			
512 6075	CROSS-PLY repair patch PN 07	295 mm	6	10	1	•			
512 6082	CROSS-PLY repair patch PN 08	345 mm	6	5	1	•			
512 6099	CROSS-PLY repair patch PN 09	390 mm	8	5	1	•			
512 6109	CROSS-PLY repair patch PN 010	450 mm	8	3	1	•			
512 6202	CROSS-PLY repair patch PN 020	255 mm	4	10	1			•	
512 6219	CROSS-PLY repair patch PN 021	370 mm	4	5	1			•	
512 6226	CROSS-PLY repair patch PN 022	510 mm	4	3	1			•	
512 6233	CROSS-PLY repair patch PN 023	255 mm	6	10	1			•	
512 6240	CROSS-PLY repair patch PN 024	370 mm	6	5	1			•	
512 6257	CROSS-PLY repair patch PN 025	510 mm	6	3	1			•	
512 6408	CROSS-PLY repair patch PN 040	160 mm	4	5	1				•
512 6415	CROSS-PLY repair patch PN 041	235 mm	6	5	1				•
512 6422	CROSS-PLY repair patch PN 042	265 mm	8	5	1				•

REPAIR AND SEALING MATERIAL FOR TYRES AND TUBES

CROSS-PLY repair patches



P·N
DIAGONAL

CROSS-PLY repair patches, series PN-OTR



512 2000

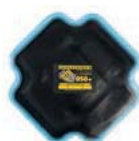

512 2017



512 2024



512 2031



512 2048



512 2055

CROSS-PLY repair patches, series PN-OTR

- Repair patches for durable repairs to cross-ply tyres of all OTR sizes
- Suitable for all the current vulcanizing systems due to the fully integrated bonding layer. Use in conjunction with the appropriate REMA TIP TOP accelerator solutions

Type:
S = sidewall patch
+ = reinforced patch
S+ = shoulder and sidewall injuries, reinforced

Ref. No.	Description	Patch Ø in cord direction	Number of plies	Content	Qty	
512 2000	CROSS-PLY repair patch PN 050	240 mm	4	12	1	•
512 2017	CROSS-PLY repair patch PN 050+	240 mm	6	10	1	•
512 2024	CROSS-PLY repair patch PN 052	360 mm	6	12	1	•
512 2031	CROSS-PLY repair patch PN 052+	360 mm	8	10	1	•
512 2048	CROSS-PLY repair patch PN 054	480 mm	8	5	1	•
512 2055	CROSS-PLY repair patch PN 054+	480 mm	10	5	1	•
512 2062	CROSS-PLY repair patch PN 056	660 mm	10	5	1	•
512 2079	CROSS-PLY repair patch PN 056+	660 mm	12	5	1	•
512 2402	CROSS-PLY repair patch PN 056 S	660 mm	10	5	1	•
512 2419	CROSS-PLY repair patch PN 056 S+	660 mm	12	5	1	•
512 2093	CROSS-PLY repair patch PN 058	810 mm	12	3	1	•
512 2103	CROSS-PLY repair patch PN 058+	810 mm	14	3	1	•
512 2433	CROSS-PLY repair patch PN 058 S	810 mm	12	3	1	•
512 2440	CROSS-PLY repair patch PN 058 S+	810 mm	14	3	1	•
512 2110	CROSS-PLY repair patch PN 060	1010 mm	14	1	1	•

REPAIR AND SEALING MATERIAL FOR TYRES AND TUBES

Chemical cleaning



505 9692



505 9702



593 0145



515 9091

LIQUID BUFFER

- Free of CFC and aromatic compounds
- For quick and easy cleaning and buffing of tubes
- For chemical cleaning before mechanical buffing
- RCF = Repair Cement Free
(Products and application completely solvent-free)

Ref. No.	Description	Content	Qty
505 9685	LIQUID BUFFER	250 ml tin	25
505 9692	LIQUID BUFFER	500 ml spray	12
505 9702	LIQUID BUFFER	1000 ml tin	10
505 9719	LIQUID BUFFER	5 l can	1
593 0145	Spray bottle for compressed air, max. 6.2 bar Suitable for solvents - With nipple for compressed air supply - Can be used like a spray can	650 ml	1
515 9091	RCF SEALER-PLUS, cementless	1000 ml	10

REPAIR AND SEALING MATERIAL FOR TYRES AND TUBES

Vulcanizing fluids



505 9128



505 9197



505 0196



505 9245



505 4051

SVS-VULC Vulcanizing fluid

- Free of CFC and aromatic compounds
- For the vulcanization of tube patches, valve patches, fabric-reinforced valve patches and rubber base valves (hot vulcanization)
- Suitable for marking label SVS
- Allows chemical vulcanization without heat input

Ref. No.	Description	Content	Qty
505 9018	SVS-VULC	3 g tube	50
505 9025	SVS-VULC	3 g tube	10
505 9032	SVS-VULC	5 g tube	50
505 9056	SVS-VULC	10 g tube	50
505 9128	SVS-VULC	25 g tube	25
505 9142	SVS-VULC	50 g tube	25
505 9159	SVS-VULC with brush top	70 g tin	15
505 9197	SVS-VULC with brush top	175 g tin	25
505 0196	SVS-VULC	175 g tin	25
505 9245	SVS-VULC	500 g tin	10
505 4037	SVS-VULC with self-service clip	5 g tube	50
505 4051	SVS-VULC with self-service clip	10 g tube	10

REPAIR AND SEALING MATERIAL FOR TYRES AND TUBES

Vulcanizing fluids

CEMENT FD-BL, free of CFC/aromatic compounds

- This accelerator solution dries twice as fast as CEMENT SC-BL
- Especially suitable for fast and smaller repairs such as to tread-area punctures and for one-step repairs with REMA TIP TOP RAD, PN and UP repair patches
- Can be used for self-vulcanization from 18 °C (65 °F) through to hot vulcanization at 150 °C (300 °F)
- Transparent and easy to distinguish from the blue CEMENT SC-BL if used in the same way



515 9410

Ref. No.	Description	Inhalt	Qty
515 9370	CEMENT FD-BL	25 g tube	1
515 9570	CEMENT FD-BL, with brush cover	175 g tin	25
515 9410	CEMENT FD-BL	500 g tin	10
515 9560	CEMENT FD-BL	3,5 kg can	1



515 9570

CEMENT SC-BL, free of CFC/aromatic compounds

- Accelerator solution for the application of REMA TIP TOP RAD, PN and UP repair patches, MINICOMBI, REMA STEM, SV bonding rubber, SEALASTIC, VULC COMPOUND
- SPECIAL CEMENT SC-BL can be universally used for self-vulcanization starting from 18° C (65° F) through to hot vulcanization up to 150° C (300° F)



515 9341

Ref. No.	Description	Content	Qty
515 9303	CEMENT SC-BL	4 g tube	50
515 9327	CEMENT SC-BL	12 g tube	50
515 9334	CEMENT SC-BL	30 g tube	25
515 9341	CEMENT SC-BL	40 g tin	25
515 9358	CEMENT SC-BL	70 g tube	25
515 9365	CEMENT SC-BL	225 g tin	25
515 9406	CEMENT SC-BL, with brush cover	225 g tin	25
515 9389	CEMENT SC-BL	650 g tin	10
515 9396	CEMENT SC-BL	4 kg can	1



515 9406



515 9389



515 9396

REPAIR AND SEALING MATERIAL FOR TYRES AND TUBES

Vulcanizing fluids

SOLUTION MTR, free of CFC/aromatic compounds

- Accelerator solution for coating the buffed tyre inside, the buffed skive surface or the bonding layer of REMA TIP TOP repair patches prior to laminating with MTR RUBBER
- Thermopress SOLUTION MTR is adapted to MTR RUBBER with regard to its accelerator and adhesion system and can therefore be used at curing temperatures of at least 100° C (212° F)



516 9207

Ref. No.	Description	Content	Qty
516 9207	SOLUTION MTR, with brush cover	350 g tin	10
516 9214	SOLUTION MTR	700 g tin	10
516 9240	SOLUTION MTR	4.5 kg can	1



515 9224

SOLUTION HR, free of CFC/aromatic compounds

- Accelerator solution for coating the buffed tyre inside during the application of RADIAL, PN, or UP repair patches, with the vulcanizing temperature being higher than 85 °C (185 °F)
- SOLUTION HR helps to extend the waiting time until the start of the curing process to a maximum of 14 days
- HR = hot repair



515 9231

Ref. No.	Description	Content	Qty
515 9224	SOLUTION HR	650 g tin	10
515 9231	SOLUTION HR	4 kg can	1



515 9430

OTR SPECIAL CEMENT, free of CFC/aromatic compounds

- Accelerator solution for coating the buffed tyre inside in conjunction with REMA TIP TOP RAD and PN OTR repair patches
- Especially suitable for repairs to large tyres used on long-haul EM vehicles, optimizing the run time of the tyre



515 9440

Ref. No.	Description	Content	Qty
515 9430	OTR SPECIAL CEMENT	650 g can	10
515 9440	OTR SPECIAL CEMENT	4 kg can	1

REPAIR AND SEALING MATERIAL FOR TYRES AND TUBES

Vulcanizing fluids

INNERLINER SEALER, free of CFC/aromatic compounds

- Sealing porous innerliners and edges of repair areas
- Coating excessively buffed repair areas on the tyre inside

Ref. No.	Description	Content	Qty
515 9028	INNERLINER SEALER, with brush cover	175 g tin	1
515 9004	INNERLINER SEALER	650 g tin	10
515 9011	INNERLINER SEALER	4 kg can	1
515 9035	INNERLINER SEALER, sprayable	3.5 kg can	1
515 9042	INNERLINER SEALER, sprayable	7 kg can	1
5159091	RCF SEALER PLUS, water-based	1 l bottle	10



515 9011

SOLUTION T2, free of CFC/aromatic compounds

- SOLUTION T2 is used for pre-treatment of the buffed skive before it is filled with T2-Compound
- The two components (A and B) are mixed in equal quantities in the amount required for the rubber surface

Ref. No.	Description	Content	Qty
517 9008	SOLUTION T2 A4	700 g tin	10
517 9015	SOLUTION T2 B4	700 g tin	10



515 9028

TT Cleaning Fluid R4, free of CFC/aromatic compounds

Prevents brushes from drying out and cleans away rubber solutions.

Ref. No.	Description	Content	Qty
595 9118	TT Cleaning Fluid R4	250 ml tin	25
595 9149	TT Cleaning Fluid R4	500 ml spray	25
595 9125	TT Cleaning Fluid R4	800 ml tin	10
595 9132	TT Cleaning Fluid R4	5 l can	1



517 9015



595 9149

REPAIR AND SEALING MATERIAL FOR TYRES AND TUBES

Repair rubber



517 3523

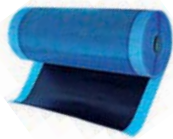

516 1250



516 1170



517 3509



516 1274



516 1164

SV bonding rubber, blue

- Self-vulcanizing cushion gum for the lamination of REMA TIP TOP RADIAL and PN repair patches
- Only apply with REMA TIP TOP CEMENT SC-BL or REMA TIP TOP CEMENT OTR

- Waiting time before putting the tyre back into operation in the case of self-vulcanization: 48 hours at a temperature of at least 18 °C (65 °F)

Ref. No.	Description	Size	Weight	Content	Qty
517 3523	SV bonding rubber, blue	approx. 8000 x 250 x 0.8 L x W x H mm	approx. 2 kg	1 roll	1
517 3509	SV bonding rubber, blue	approx. 10000 x 500 x 0.8 L x W x H mm	approx. 5 kg	1 roll	1

MTR RUBBER

- Uncured rubber compound for filling skives in all areas on the tyre
- Good flowing and vulcanizing characteristics
- Required vulcanizing temperature: at least 100°C (212°F)
- Max. temperature for warming up MTR RUBBER 80°C (176°F)

- MTR RUBBER provides excellent adhesion to the tyre and has high resistance to dynamic stress
- Use only with SOLUTION MTR

Ref. No.	Description	Size	Weight	Content	Qty
516 1243	MTR RUBBER	approx. 2500 x 150 x 0.8 L x W x H mm	approx. 0.5 kg	1 roll	1
516 1267	MTR RUBBER	approx. 2600 x 30 x 3.0 L x W x H mm	approx. 1 kg	3 rolls	1
516 1250	MTR RUBBER	approx. 7200 x 250 x 1.2 L x W x H mm	approx. 2.5 kg	1 roll	1
516 1274	MTR RUBBER	approx. 2600 x 500 x 3.0 L x W x H mm	approx. 5 kg	1 roll	1
516 1170	MTR RUBBER, rope for extruder	Ø approx. 8 mm	approx. 6 kg	1 rope	1
516 1164	MTR RUBBER, rope for extruder	Ø approx. 8 mm	approx. 12 kg	1 rope	1

REPAIR AND SEALING MATERIAL FOR TYRES AND TUBES

Repair rubber

MTR SUPER FINISH RUBBER

- Uncured rubber compound for excellent surface finish particularly in the tyre sidewall area
- Good flowing and vulcanizing characteristics
- Required vulcanizing temperature: at least 100 °C (212°F)
- Max. temperature for warming up MTR SUPER FINISH RUBBER 80 °C (176 °F)
- Use only with SOLUTION MTR



516 0980

Ref. No.	Description	Size	Weight	Content	Qty
516 0980	MTR SUPER FINISH RUBBER, rope for extruder	Ø 8 mm	approx. 12 kg	1 rope	1

MTR-CR RUBBER

- Uncured rubber for increased wear and cut resistance
- Required vulcanizing temperature: at least 100 °C (212 °F)
The skive can be filled with MTR-CR RUBBER only or in combination with MTR RUBBER
- If working with two compounds, use MTR-CR RUBBER as a protector above the casing
- Please only use with SOLUTION MTR
- CR = cut resistant



516 1180

Ref. No.	Description	Size	Weight	Content	Qty
516 1180	MTR-CR, rope for extruder	Ø 8 mm	approx. 12 kg	1 rope	1

MTR cushion gum

- Cushion gum for laminating REMA TIP TOP repair patches prior to vulcanization in retreading systems/vulcanizing machines at an operating temperature of over 100°C (212°F)
- The excellent initial tack and ageing stability under thermal stress ensure improved adhesion even when used in open steam autoclaves or long curing processes
- Please use MTR cushion gum with SOLUTION MTR only!



516 1009

Ref. No.	Description	Size	Weight	Content	Qty
516 1009	MTR cushion gum	approx. 1 x 500 x 8000 H x W x L mm	approx. 5 kg	1 roll	1

REPAIR AND SEALING MATERIAL FOR TYRES AND TUBES

Repair rubber



516 9087



517 7323



517 7330

FIXPASTE VC4-A+B, free of CFC/aromatic compounds

- For the repair of rubber damage to tyres and conveyor belts by cold vulcanization
- Use with CEMENT SC-BL

Ref. No.	Description	Content	Qty
516 9032	FIXPASTE VC4-A+B	300 g each	1
516 9049	FIXPASTE VC4-A+B	650 g each	1
516 9056	FIXPASTE VC4-A+B	3 kg each	1
516 9063	FIXPASTE VC4-A+B	6 kg each	1
516 9087	FIXPASTE VC4-A+B kit includes 1x FIXPASTE VC4-A 650 g tin, 1x FIXPASTE VC4-B, 650 g tin, 1x CEMENT SC-BL, 225 g tin		1
516 9025	FIXPASTE VC4-A+B kit includes 1x FIXPASTE VC4-A 150 g tin, 1x FIXPASTE VC4-B, 150 g tin, 1x CEMENT SC-BL, 40 g		1

T2-COMPOUND

- The solvent-free compound consisting of two components is mixed in the REMA TIP TOP Compound Master and applied to the repair location that was prepared with SOLUTION T2
- High initial elasticity
- Quick vulcanization
- Constant technical properties and good abrasion resistance
- Hand extruders should be cleaned using REMA TIP TOP T2 cleaning rubber

Ref. No.	Description	Size	Weight	Content	Qty
517 7323	T2-COMPOUND A	3 x 20 x 5500 H x W x L mm	2 kg	5 rolls	1
517 7330	T2-COMPOUND B	3 x 20 x 5500 H x W x L mm	2 kg	5 rolls	1
517 7300	T2-COMPOUND A, rope for extruder Supplied in plastic bucket - Stays protected against environmental factors if left in opened plastic bucket	Ø 8 mm	6 kg	1 rope	1
517 7310	T2-COMPOUND B, rope for extruder Supplied in plastic bucket - Stays protected against environmental factors if left in opened plastic bucket	Ø 8 mm	6 kg	1 rope	1

REPAIR AND SEALING MATERIAL FOR TYRES AND TUBES

Repair rubber

T2-CL Cleaning rubber

For cleaning hand extruder.

Ref. No.	Description	Size	Weight	Content	Qty
517 7402	T2-CL	approx. 3 x 20 x 3000 H x W x L mm	approx. 1 kg	5 rolls	1
517 7420	T2-CL rope for extruder	Ø approx. 8 mm	approx. 6 kg	1 rope	1



517 7402

Supporting material

Heat resistant gliding foil

- This special foil is put between the repair area and the heating plate
- It prevents the repair from sticking to the Thermopress heating plate
- Max. temperature resistance approx. 160°C
- Foil thickness approx. 0.2 mm



517 1972

Ref. No.	Description	Size	Content	Qty
517 1972	Heat resistant foil, yellow	approx. 160 x 75 mm	1000 sheets	1
517 6977	Heat resistant gliding foil, white	approx. 500 x 300 mm	10 sheets	1



517 6977

Pressure compensation cloth

- Prevents the EM heating pockets from adhering to the skive
- Better pressure distribution
- Bubble-free release of air from the skive
- Blocks the excess rubber
- Reusable

Ref. No.	Description	Width	Content	Qty
538 1009	Pressure equalizing cloth, sold by meters (per meter)	1250 mm	1	1



538 1009

REPAIR AND SEALING MATERIAL FOR TYRES AND TUBES

Supporting material



REMA TIP TOP repair patch templates

REMA TIP TOP patch templates facilitate the marking of the patch at the repair location.

Ref. No.	Description	Suitable for	Content	Qty
513 1079	Template 20	RAD 120, M-RCF 420, M-RCF 420+	1	1
513 1086	Template 22	RAD 122	1	1
513 1093	Template 24	RAD 124, M-RCF 424	1	1
513 1157	Template 25	RAD 125, M-RCF 425+	1	1
513 1102	Template 26	RAD 126, M-RCF 426	1	1
513 1119	Template 28	RAD 128	1	1
513 1164	Template 35	RAD 135	1	1
513 1127	Template 40	RAD 140, M-RCF 440, M-RCF 440+	1	1
513 1134	Template 42	RAD 142, M-RCF 442, M-RCF 442+	1	1
513 1141	Template 44	RAD 144	1	1
513 1171	Template 46	RAD 146	1	1
513 1195	Template 31	RAD 331, RAD 531	1	1
513 1205	Template 33	RAD 333, RAD 533	1	1
513 1212	Template 35	RAD 335, RAD 535	1	1
513 1229	Template 37	RAD 337, RAD 537	1	1
513 1236	Template 39	RAD 339, RAD 539	1	1

REPAIR AND SEALING MATERIAL FOR TYRES AND TUBES

Supporting material



595 0186



595 4649



595 8308



595 8315



595 8322



595 8353



595 8380

Brushes for solutions

The thickness of the brush and the hardness of the bristles have a determining influence on the quality and economy of the coat of cement in the skive, on the inner liner and on the patch.

Ref. No.	Description	Dia.	Length	Length of handle	Width	Content	Qty
595 0186	Brush, with natural fibre Suitable for: All cements	35 mm	30 mm	170 mm		1	1
595 4649	Brush cover, with brush					1	1
595 8308	Special brush, with short fibre bristles Suitable for: CEMENT SC-BL, SOLUTION HR etc.	20 mm	39 mm	165 mm		1	1
595 8315	Special brush, with short fibre bristles Suitable for: CEMENT SC-BL, SOLUTION HR etc.	38 mm	40 mm	210 mm		1	1
595 8322	Flat brush, with short bristles Suitable for: INNERLINER SEALER		25 mm	135 mm	25 mm	1	1
595 8353	Brush, with screw top Suitable for: 175 g and 225 g tins					10	1
595 8380	RCF Rotary brush Suitable for: RCF Fast Dry Buffer	100 mm				1	1

REPAIR AND SEALING MATERIAL FOR TYRES AND TUBES

Supporting material



595 4508



595 4820



595 8298



593 0649



595 9310



595 8346



595 8370

Tins with brushes

Storage brushes and detergents.

Ref. No.	Description	Dia.	Content	Qty
595 4508	Aluminium can, with brush cover		1	1
595 4820	Zinc tin, with brush cover		1	1
595 8298	Brush cleaning tin UNIVERSAL, with brush		1	1
595 8346	Tin cover, with brush adapter Suitable for: Zinc tin	50 mm	1	1
595 8370	Plastic cover, with brush adapter Suitable for: Bead Sealer	60 mm	1	1
595 9310	Rubber brush cover Suitable for: 515 9091 RCF SEALER PLUS and 595 8298 brush tin	60 mm	1	1

Talc

For mounting tube tyres and as care product/lubricant for rubber articles. Fine-grained. Asbestos free.

Ref. No.	Description	Content	Qty
593 0649	Talc	500 g can	10
593 0687	Talc	25 kg in bag	1



SPECIAL MATERIAL FOR RETREADING

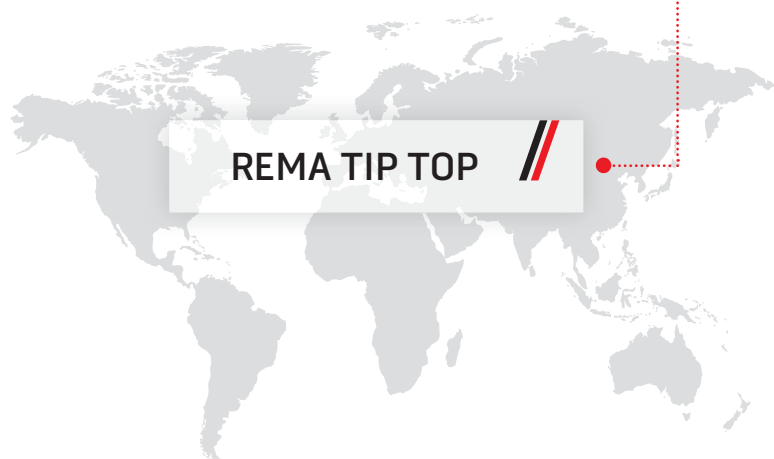

REMA TIP TOP



Cutting and buffing tools	46-62
Buffing tools for retreaders	63
Special repair material for retreaders	64-65
Hand and cutting tools	66
Measuring tools	67
Pneumatic tools	68-69
Electric tools	70-72
Extruders	73-74
Marking / Branding	75-77

SPECIAL MATERIAL FOR RETREADING

Cutting and buffing tools



511 1705



511 1712



511 1729



511 1736



511 1743



595 4326



595 4328





595 4292



595 4481



Compass saw for steel cord tyres

For cylindrical removal of damaged material from tyres.

Ref. No.	Description	Speed (rpm)	Dia.		Content	Qty		
511 1705	Compass saw	max. 2000	22 mm	511 1736	1	1	•	•
511 1712	Compass saw	max. 2000	32 mm	511 1743	1	1	•	•
511 1729	Compass saw	max. 2000	41 mm	511 1743	1	1	•	•
511 1736	Arbour hexagon, for compass saw	max. 2000	22 mm		1	1		
511 1743	Arbour hexagon, for compass saw	max. 2000	32/41 mm		1	1		

Rotary gouges

- Rotary gouge for the removal of loose rubber
- Clean elimination of cut rubber facilitated by integrated internal thread
- Heat-resistant steel provides long service life
- All rotary gouges can be easily re-sharpened
- For precise sharpening of rotary gouges the special sharpening fixture is recommended

Ref. No.	Description	Thread	Speed (rpm)	Dia.				Content	Qty				
595 4328	Rotary gouge, Micro	3/8 Inch	max. 4500	approx. 19 mm	595 4034	519 6610		4	1	•			
595 4326	Rotary gouge, mini	3/8 Inch	max. 4500	30 mm	595 4034	519 6610		3	1		•	•	•
595 4292	Rotary gouge, maxi	3/8 Inch	max. 4500	50 mm	595 4034	519 6610	595 4027	1	1		•	•	•
595 4481	Sharpening fixture							1	1				

SPECIAL MATERIAL FOR RETREADING

Cutting and buffing tools



Carbide cutter

- For precise injury preparation on radial and cross-ply tyres
- Special profile adapted to steel cord preparation allows professional grinding out of the injury
- Long service life
- All HM cutters are packed individually in a robust plastic box

Ref. No.	Description	Speed (rpm)	Dia.	Blade length	Length							
595 5019	HM mill cutter, pointed	max. 2500	4.5 mm	30 mm	90 mm	fixed shaft 6 mm	519 6672	595 0519	•	•	•	•
595 4962	HM mill cutter, pointed	max. 2500	6 mm	50 mm	90 mm	fixed shaft 6 mm	519 6672	595 0519	•	•	•	•
595 4948	HM mill cutter, pointed	max. 2500	8 mm	50 mm	100 mm	fixed shaft 8 mm	519 6689	595 4278	•	•	•	•
595 5002	HM mill cutter, pointed (extra long) Suitable for: SEALASTIC EM preparation of injuries using a hand drill	max. 2500	9.5 mm	60 mm	250 mm	fixed shaft 10 mm	519 6593	595 4027 with 519 6593				•
595 5060	HM mill cutter, pointed	max. 2500	10 mm	60 mm	110 mm	fixed shaft 10 mm	519 6593	595 4027 with 519 6593	•	•	•	•
595 5040	HM mill cutter, pointed	max. 2500	12 mm	60 mm	110 mm	fixed shaft 10 mm	519 6593	595 4027 with 519 6596	•	•	•	•
595 4900	HM router/burr, pointed	max. 25000	3 mm	25 mm	50 mm	fixed shaft 3 mm	519 6782	595 4027 with 519 6782	•	•		
595 4924	HM router/burr, pointed	max. 25000	6 mm	25 mm	65 mm	fixed shaft 6 mm	519 6672	595 0519	•			•
595 4931	HM router/burr, blunt headed	max. 25000	6 mm	25 mm	65 mm	fixed shaft 6 mm	519 6672	595 0519	•			•
595 4955	HM Ballshaped burr	max. 25000	20 mm			fixed shaft 6 mm	519 6672	595 0519	•			•

SPECIAL MATERIAL FOR RETREADING Cutting and buffing tools



HSS mill cutters

• For cylindrical enlargement and cleaning of smaller tread-area punctures







• HSS mill cutters have to be replaced after max. 25 repairs because of wear

Ref. No.	Description	Speed (rpm)	Dia.	Length			
595 4917	HSS mill cutter	max. 2500	3 mm	60 mm	fixed shaft 3 mm	519 6782	595 4027 with 519 6782
511 1767	HSS mill cutter	max. 2500	4.5 mm	110 mm	fixed shaft 4,5 mm		
511 1781	HSS mill cutter	max. 2500	6 mm	110 mm	fixed shaft 6 mm	519 6672	595 4027 with 519 6672
511 1798	HSS mill cutter	max. 2500	8 mm	110 mm	fixed shaft 8 mm	519 6689	519 6689 with 595 4027

Chip cones, Classic class

• The copper coloured carbide buffing tools have a very long lifespan
• Their quality in measurement and roundness without vibration is outstanding and unique

• Optimised removal of rubber
• For buffing rubber on stitch damages and narrow spots

Ref. No.	Description	Thread	Speed (rpm)	Dia.	Length						
595 0746	Chip cone K 18, rounded	3/8 Inch	max. 4500	20 mm	38 mm	595 4034	519 6610	595 4027	•	•	
595 8872	Chip cone K 18, pointed	3/8 Inch	max. 4500	25 mm	50 mm	595 4034	519 6610	595 4027	•		•
595 0739	Chip cone K 18, pointed	3/8 Inch	max. 4500	25 mm	102 mm	595 4034	519 6610	595 4027	•	•	
595 8982	Chip cone K 36, pointed	3/8 Inch	max. 4500	25 mm	102 mm	595 4034	519 6610	595 4027	•	•	

SPECIAL MATERIAL FOR RETREADING

Cutting and buffing tools



Pencil buffers, Classic class

- The copper coloured carbide buffing tools have a very long lifespan
- Their quality in measurement and roundness without vibration is outstanding and unique
- Optimised removal of rubber
- For buffing of rubber in nailhole type injuries

Ref. No.	Description	Speed (rpm)	Dia.	Length						
595 5057	Pencil buffer K 36	max. 4500	4 - 6 mm	65 mm	fixed shaft 6 mm	519 6672	595 0519	•	•	
595 8913	Pencil buffer K 46	max. 4500	4 - 8 mm	102 mm	fixed shaft 6 mm	519 6672	595 0519	•	•	
595 8906	Pencil buffer K 18	max. 4500	5 - 8 mm	105 mm	fixed shaft 6 mm	519 6672	595 0519	•	•	
595 8896	Pencil buffer K 36	max. 4500	5 - 8 mm	105 mm	fixed shaft 6 mm	519 6672	595 0519	•	•	
595 0753	Pencil buffer K 18	max. 4500	6 mm	65 mm	fixed shaft 6 mm	519 6672	595 0519	•	•	
595 8968	Pencil buffer K 18	max. 4500	8 mm	170 mm	fixed shaft 8 mm	519 6689	595 4278			•
595 8951	Pencil buffer K 36	max. 4500	8 mm	170 mm	fixed shaft 8 mm	519 6689	595 4278			•

SPECIAL MATERIAL FOR RETREADING

Cutting and buffing tools



595 8762



595 8755



595 8786



595 8793



595 8810



595 8858



595 6070



595 4388



595 8834



595 8827

Buffing wheels, Classic class

- The copper coloured carbide buffing tools have a very long lifespan
- Their quality in measurement and roundness without vibration is outstanding and unique
- Optimised number and placement of cooling holes and slots
- Optimised and efficient removal of rubber

Ref. No.	Description	Thread	Speed (rpm)	Dia.	Bore Ø	Width						
595 8755	Buffing wheel K 16	3/8 Inch	max. 4500	50 mm		3 mm	595 4034	519 6610	595 4027	•	•	
595 8786	Buffing wheel K 18	3/8 Inch	max. 4500	50 mm		3 mm	fixed shaft 6 mm	519 6672		•	•	
595 8793	Buffing wheel K 18	3/8 Inch	max. 4500	50 mm		3 mm	595 4034	519 6610	595 4027	•	•	•
595 8779	Buffing wheel K 36	3/8 Inch	max. 4500	50 mm		3 mm	fixed shaft 6 mm	519 6672		•	•	
595 8762	Buffing wheel K 14	3/8 Inch	max. 4500	50 mm		5 mm	595 4034	519 6610	595 4027	•	•	•
595 8810	Buffing wheel K 18	3/8 Inch	max. 4500	50 mm		5 mm	595 4034	519 6610	595 4027	•	•	•
595 8858	Buffing wheel K 18	3/8 Inch	max. 4500	50 mm		10 mm	595 4034	519 6610	595 4027	•	•	•
595 4388	Buffing wheel K 18	3/8 Inch	max. 4500	50 mm		13 mm	595 4034	519 6610	595 4027	•	•	
595 6070	Buffing wheel K 18	3/8 Inch	max. 4500	50 mm		13 mm	595 4034	519 6610	595 4027	•	•	
595 4395	Buffing wheel K 36	3/8 Inch	max. 4500	50 mm		13 mm	595 4034	519 6610	595 4027	•	•	
595 8834	Buffing wheel K 18		max. 4500	76 mm	14 mm	16 mm	595 4261	519 6634	595 4285	•	•	
595 8827	Buffing wheel K 18	3/8 Inch	max. 4500	50 mm		19 mm	595 4034	519 6610	595 4027	•	•	
595 8841	Buffing wheel K 18		max. 4500	102 mm	14 mm	19 mm	595 4261	519 6634	595 4285	•	•	

SPECIAL MATERIAL FOR RETREADING

Cutting and buffing tools



595 8999



595 8865



595 4247



595 4223



595 9000



595 4209



595 8975



595 4216



595 4230

Domed contour rasps, Classic class

- The copper coloured carbide buffing tools have a very long lifespan
- Their quality in measurement and roundness without vibration is outstanding and unique
- Optimised number and placement of cooling holes and slots
- Optimised and efficient removal of rubber
- For buffing on inner liner, or for finish buffing of the skive filling

Ref. No.	Description	Thread	Speed (rpm)	Dia.	Bore Ø										
595 9000	Dome rasp K 36	3/8 Inch	max. 4500	30 mm		595 4034	519 6610	595 4027							
595 8865	Dome rasp K 18	3/8 Inch	max. 4500	50 mm		595 4034	519 6610	595 4027	•	•	•				
595 8975	Dome rasp K 36	3/8 Inch	max. 4500	50 mm		595 4034	519 6610	595 4027			•				•
595 4216	Dome rasp K 36		max. 4500	65 mm	10 mm	595 4034	519 6627	595 4027				•			•
595 4319	Dome rasp K 46		max. 4500	65 mm	3/8 Inch	595 4034	519 6627	595 4027				•			•
595 8999	Dome rasp K 14		max. 4500	76 mm	16 mm	595 4261	519 6634	595 4285	•	•					
595 4223	Dome rasp K 18		max. 4500	76 mm	14 mm	595 4261	519 6634	595 4285		•	•				
595 4209	Dome rasp K 36		max. 4500	76 mm	14 mm	595 4261	519 6634	595 4285			•				•
595 4247	Dome rasp K 18		max. 4500	102 mm	14 mm	595 4261	519 6634	595 4285	•	•					
595 4230	Dome rasp K 36		max. 4500	102 mm	14 mm	595 4261	519 6634	595 4285			•				•

SPECIAL MATERIAL FOR RETREADING

Cutting and buffing tools



595 8920



595 4715







595 4716



595 4717





Ball shaped chip rasps, Classic class

- The copper coloured carbide buffing tools have a very long lifespan
- Their quality in measurement and roundness without vibration is outstanding and unique
- Optimised and efficient removal of rubber

Ref. No.	Description	Speed (rpm)	Dia.					
595 8920	Ball shaped chip rasp K 18	max. 4500	20 mm	fixed shaft 6 mm	519 6672	595 0519	•	•

Mini buffing tools, Silver class

- Buffing tool for fine detail work
- Small dimensions for precise work
- Fine granulation with extra-long durability
- Perfect sustainability

Ref. No.	Description	Speed (rpm)	Dia.	Length				
595 4715	Mini ball rasp K 46	max. 4500	10 mm		fixed shaft 3 mm	519 6782	•	•
595 4716	Mini cone rasp K 46	max. 4500	6 mm	15 mm	fixed shaft 3 mm	519 6782	•	•
595 4717	Mini chip rasp K 46	max. 4500	15 mm		fixed shaft 3 mm	519 6782	•	•





SPECIAL MATERIAL FOR RETREADING

Cutting and buffing tools









Ball rasp, Silver class

For the finishing of rubber surfaces

Ref. No.	Description	Speed (rpm)	Dia.					
595 4371	Ball rasp K 36	max. 4500	19 mm	fixed shaft 1/4 Inch	519 6672	595 0519	.	.

Domed buffing rasps and chip cone rasp, Silver class

- The outstanding quality of the Silver Class range makes these tools unique
- Particularly suitable for sensitive buffings of the inside/innerliner of tyres
- For finishing work on rubber surfaces

Ref. No.	Description	Speed (rpm)	Dia.	Bore Ø	Length						
595 4735	Dome rasp K 60	max. 4500	32 mm	3/8 Inch	18 mm	595 4034	519 6610	595 4027	.	.	.
595 4687	Dome rasp K 36	max. 4500	32 mm	3/8 Inch	18 mm	595 4034	519 6610	595 4027	.	.	.
595 4632	Dome rasp K 36	max. 4500	44 mm	3/8 Inch	19 mm	595 4034	519 6610	595 4027	.	.	.
595 4656	Dome rasp K 36	max. 4500	76 mm	14 mm		595 4261 with PU insert 595 0533	519 6634 with PU insert 519 6665	595 4285 not possible with PU insert	.	.	.
595 4704	Chip rasp K 18, blunt headed	max. 4500	11 - 22 mm	—	50 mm	595 4034	519 6610	595 4027	.	.	.
595 4740	Pencil buffer K 36, pointed	max. 4500	6 mm	—	75 mm	Fester Schaft 6 mm	519 6672		.	.	.

SPECIAL MATERIAL FOR RETREADING Cutting and buffing tools



595 4330



595 7866



595 6056



595 6087



595 6111

Domed contour rasps, Gold class

- Outstandingly long lifespan
- Efficient removal of rubber thanks to unique cooling technology

Ref. No.	Description	Thread	Speed (rpm)	Dia.	Bore Ø									
595 4330	Dome rasp K 36, Patriot		max. 4500	76 mm	14 mm	595 4261	519 6634	595 4285						
595 7866	Dome rasp K 36, Patriot	3/8 Inch	max. 4500	50 mm		595 4034	519 6610	5954027						

Domed contour rasps, REMA TIP TOP class

- Economy series for buffing of rubber surfaces
- Carbide buffing tool

Ref. No.	Description	Thread	Speed (rpm)	Dia.	Bore Ø						
595 6056	Dome rasp K 16	3/8 Inch	max. 4500	50 mm		595 4034	519 6610	595 4027			
595 6087	Dome rasp K 16		max. 4500	76 mm	14 mm	595 4261	519 6634	595 4285			
595 6111	Dome rasp K 16		max. 4500	102 mm	14 mm	595 4261	519 6634	595 4285			

SPECIAL MATERIAL FOR RETREADING

Cutting and buffing tools



595 6001



595 6018



595 6049



595 2548



595 2555



595 2531



595 2562

Buffing wheels, REMA TIP TOP class

- Economy series for buffing of rubber surfaces
- Carbide buffing tool

Ref. No.	Description	Thread	Speed (rpm)	Dia.	Height						
595 6001	Buffing wheels K 16	3/8 Inch	max. 4500	50 mm	3 mm	595 4034	519 6610	595 4027	•	•	•
595 6018	Buffing wheels K 16	3/8 Inch	max. 4500	50 mm	5 mm	595 4034	519 6610	595 4027	•	•	•
595 6049	Buffing wheels K 16	3/8 Inch	max. 4500	50 mm	10 mm	595 4034	519 6610	595 4027	•	•	•

Buffing discs for angle grinders

For the preparation of large rubber surfaces on the outside of a tyre.

Ref. No.	Description	Speed (rpm)	Dia.	Bore Ø	Height	Content	Qty	
595 2548	Buffing disc K 23	max. 4500	125 mm	22 mm	2 mm	1	1	•
595 2555	Buffing disc K 18	max. 4500	175 mm	22 mm	2 mm	1	1	•
595 2531	Buffing disc K 18	max. 4500	125 mm	22 mm	2 mm	1	1	•
595 2562	Buffing disc K 23	max. 4500	175 mm	22 mm	2 mm	1	1	•

SPECIAL MATERIAL FOR RETREADING

Cutting and buffing tools



595 0730



595 4175



595 4168



595 4522



595 0722



595 0076

Rotary plastic brush

• The rotary brush with plastic (SiC) bristles is designed for repairs of Yokohama car and truck tyres which are fitted with a new type of »AIRTEX TM« innerliner

• The brush allows gentle removal of the »AIRTEX TM« innerliner

Ref. No.	Description	Speed (rpm)	Dia.	Width						
595 0730	Rotary plastic brush SiC	max. 3000	50 mm	18 mm	fixed shaft 6 mm	519 6672	595 0519			

Rotary wire brushes

• The rotary wire brushes are made with crimped wires in different qualities
 • They are ideal for use in power drills, air buffers and flexible shafts

• For the careful treatment of rubberized steel cord to achieve an optimal buffing texture
 • The rotary brushes with brush body encapsulated in a synthetic compound guarantee a long service life

Ref. No.	Description	Speed (rpm)	Dia.	Bore Ø	Width												
595 4175	Rotary brush, contour embedded in plastic	max. 2800	76 mm	14 mm	20 mm	595 0533	519 6665	595 4285									
595 4168	Rotary brush, cylindrical, plastic embedded	max. 2800	76 mm	14 mm	8 mm	595 0533	519 6634	595 4285									
595 4522	Rotary brush, cylindrical, plastic embedded	max. 2800	50 mm	3/8 Inch	7 mm	595 4034	519 6627										
595 4182	Rotary brush, cylindrical, plastic embedded	max. 2800	76 mm	14 mm	20 mm	595 0533	519 6634	595 4285									
595 0722	Rotary brush, cylindrical, brass-coated steel wire	max. 2800	55 mm		8 mm	fixed shaft 6 mm	519 6672										
595 0076	Rotary brush, steel wire	max. 2800	60 mm		20 mm	fixed shaft 6 mm	519 6672										

SPECIAL MATERIAL FOR RETREADING

Cutting and buffing tools



595 0571



595 0564



595 4560



595 0117



595 0588



595 0595



595 0605



595 0083

Ref. No.	Description	Speed (rpm)	Dia.	Bore Ø	Width								
595 0571	Rotary brush, cylindrical	max. 2800	80 mm	16 mm	25 mm	595 0540	519 6689	595 0502	•	•			
595 0564	Rotary brush, cylindrical	max. 2800	100 mm	16 mm	25 mm	595 0540	519 6689	595 0502	•	•			
595 4560	Spiral/pencil brush For the repair of very small injuries	max. 2800	8 mm		25 mm	fixed shaft 6 mm	519 6672				•		•

Limestones

- The »limestones« are designed for buffing rubber surfaces
- The special hollow-sphere corundum surface gives a fine, permanent razor-sharp cutting edge for gentle removal of material

- These tools are therefore particularly suitable for soft rubber grades

Ref. No.	Description	Speed (rpm)	Dia.	Bore Ø	Width								
595 0117	Limestone, cylindrical	max. 4500	60 mm		15 mm	595 0100	595 0100 + 519 6672		•	•			
595 0588	Limestone, cylindrical	max. 4500	90 mm	16 mm	30 mm	595 0540	595 0540 + 519 6689	595 0540 + 595 0502	•		•		
595 0595	Limestone, rounded	max. 4500	90 mm	16 mm	30 mm	595 0540	595 0540 + 595 6689	595 0540 + 595 0502			•	•	
595 0605	Limestone, spherical, M12	max. 4500	60 mm			595 0557	595 0557 + 519 6689	595 0557 + 595 0526			•	•	
595 0083	Limestone, spherical, with shaft	max. 4500	38 mm			fixed shaft 6 mm	519 6672				•		•

SPECIAL MATERIAL FOR RETREADING

Cutting and buffing tools



595 0650



595 0629



595 4405



595 4810



595 0667



595 0636



595 4780



595 4797



595 4412



595 0681

Grinding tools for steel cord preparation

- For grinding and removal of damaged steel cord on tyres
- The grinding tools are manufactured from a special ceramic bond and white corundum
- Sharp-edged white corundum gives high removal rates on steel cord

Ref. No.	Description	Speed (rpm)	Dia.	Length	Width								
595 0650	Round mushroom stone, pointed	max. 25000	40 mm		10 mm	fixed shaft 6 mm	519 6672		•	•	•	•	•
595 0629	Cone stone	max. 25000	20 mm	65 mm		fixed shaft 6 mm	519 6672		•		•		•
595 4405	Pencil stone	max. 25000	8 mm	25 mm		fixed shaft 6 mm	519 6672		•		•		•
595 4810	Pointed cone stone	max. 25000	14 mm	45 mm		fixed shaft 6 mm	519 6672		•	•	•	•	•
595 0667	Grinding disc, cylindrical Bore Ø: 16 mm	max. 9000	76 mm		7 mm	595 0674	595 0674 + 519 6689	595 0674 + 595 4278	•		•		•
595 0636	Grinding disc, cylindrical Bore Ø: 16 mm	max. 9000	100 mm		10 mm	595 0674	595 0674 + 519 6689	595 0674 + 595 4278	•		•		•
595 4780	Cutting disc, blunt	max. 25000	25 mm		6 mm	fixed shaft 6 mm	519 6672		•	•	•	•	•
595 4797	Cutting disc	max. 25000	50 mm		10 mm	fixed shaft 6 mm	519 6672		•		•		•
595 4412	Round mushroom stone, pointed	max. 25000	32 mm		6 mm	fixed shaft 6 mm	519 6672		•	•	•	•	•
595 0681	Ball stone, spherical	max. 25000	20 mm			fixed shaft 6 mm	519 6672		•	•	•	•	•

SPECIAL MATERIAL FOR RETREADING

Cutting and buffing tools



595 5507



595 5521



595 5514



595 5552





595 5576



595 5569

Finish buffer ES

- The ES buffing bands can be mounted or removed by turning them slightly to the right
- Buffing bands are easier and quicker to replace
- They are ideal for finished buffing when the skive filling has cooled down

Ref. No.	Description	Speed (rpm)	Dia.	Height							
595 5507	ES 45 finish buffer kit K 60	max. 2800	45 mm	30 mm	fixed shaft 6 mm	519 6672	•	•			
595 5521	Spare buffing band K 40 Suitable for: ES 45 buffing tool	max. 2800	45 mm	30 mm			•	•			
595 5514	Spare buffing band K 60 Suitable for: ES 75 buffing tool	max. 2800	45 mm	30 mm			•		•		
595 5552	ES 75 finish buffer kit K 60	max. 2800	75 mm	30 mm	fixed shaft 8 mm	519 6689	•			•	
595 5576	Spare buffing band K 40 Suitable for: ES 75 buffing tool	max. 2800	75 mm	30 mm			•				•
595 5569	Spare buffing band K 60 Suitable for: ES 75 buffing tool	max. 2800	75 mm	30 mm			•				•

SPECIAL MATERIAL FOR RETREADING

Cutting and buffing tools



595 0100



595 3932



595 4034



595 4302



595 0533



595 0540



595 0557



595 4261



519 6270



595 0674

Jacob chuck type arbours

For secure mounting of buffing tools on driving machine.

Ref. No.	Description	Shaft dia.	Thread	Content	Qty
595 0100	Arbour Suitable for: Limestone, cylindrical	6 mm	M6	1	1
595 3932	Arbour Suitable for: Buffing tools with 3/8" thread	6 mm	3/8 Inch	1	1
595 4034	Arbour Suitable for: Buffing tools with 3/8" thread	8 mm	3/8 Inch	1	1
595 4302	Arbour Suitable for: Buffing tools with 3/8" thread	8 mm	3/8 Inch	1	1
595 0533	Arbour Suitable for: Buffing tools with M14 bore; Dome rasp with POLYPLUG 76 mm	8 mm	M14	1	1
595 0540	Arbour Suitable for: Buffing tools with M14 bore; Rotary wire brush; Limestone	8 mm	M14	1	1
595 0557	Arbour Suitable for: Buffing tools with M12 bore	8 mm	M12	1	1
595 4261	Arbour Suitable for: Buffing tools with M14 bore	8 mm	M14	1	1
519 6270	Arbour Suitable for: Buffing rasps R5 / R6	8 mm		1	1
595 0674	Arbour Suitable for: Cylindric grinding discs	8 mm	M10	1	1

SPECIAL MATERIAL FOR RETREADING

Cutting and buffing tools



519 6603



519 6782



519 6672



519 6689



519 6593



519 6610



519 6627



519 6634



519 6641



519 6665

Arbours - adapters for quick release chuck type

For the secure fastening of buffing tools in the quick coupling.

Ref. No.	Description	Thread	Content	Qty
519 6603	Quick release action chuck QC Suitable for: Arbour NV 11	3/8"	1	1
519 6782	Arbour NV 11 Suitable for: Buffing tools with 3 mm shaft		1	1
519 6672	Arbour NV 11 Suitable for: Buffing tools with 6 mm shaft		1	1
519 6689	Arbour NV 11 Suitable for: Buffing tools with 8 mm shaft		1	1
519 6593	Arbour NV 11 Suitable for: Buffing tools with 10 mm shaft		1	1
519 6610	Arbour NV 11 Suitable for: Buffing tools with 3/8" thread	3/8" x 12 mm	1	1
519 6627	Arbour NV 11 Suitable for: Buffing tools with 3/8" thread	3/8" x 21 mm	1	1
519 6634	Arbour NV 11 Suitable for: Contour discs and buffing wheels with Ø 76 mm + Ø 102 mm	M14 x 11 mm	1	1
519 6641	Arbour NV 11 Suitable for: Buffing rasp R5 / R6		1	1
519 6665	Arbour NV 11 Suitable for: Wire brush; Buffing wheel with PU insert	M14 x 18 mm	1	1

SPECIAL MATERIAL FOR RETREADING

Cutting and buffing tools



595 0519



595 4278



595 4027



595 0526



595 0502



595 4285



519 6263



595 4010

Flex drive arbours MK 1

For secure mounting of buffing tools to flexible shafts.

Ref. No.	Description	Thread	Content	Qty
595 0519	Arbour MK 1 collet chuck type Suitable for: All tools with 6 mm shaft		1	1
595 4278	Arbour MK 1 collet chuck type Suitable for: All tools with 8 mm shaft		1	1
595 4027	Arbour MK 1 Suitable for: Buffing tools with 3/8" thread, 3/8" bore	3/8"	1	1
595 0526	Arbour MK 1 Suitable for: Buffing tools with M12 thread	M12	1	1
595 0502	Arbour MK 1 Suitable for: Rotary wire brush; Limestone; Tools with 16 mm attachment	M10	1	1
595 4285	Arbour MK 1 Suitable for: Buffing tools with 14 mm bore	M14	1	1
519 6263	Arbour MK 1 Suitable for: Buffing rasps R5 / R6; Tools with 16 mm attachment		1	1
595 4010	Arbour MK 1 Suitable for: Quick coupling	3/8"	1	1

SPECIAL MATERIAL FOR RETREADING
Buffing tools for retreaders



Buffing brushes



Buffing and grinding wheels



Buffing rasps for retreading

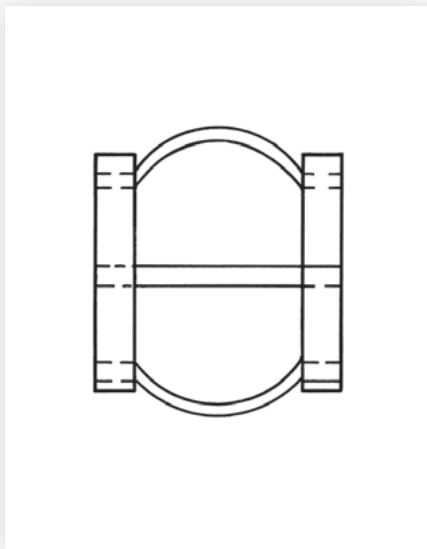

DETREADER blades for buffing machines



Spacers

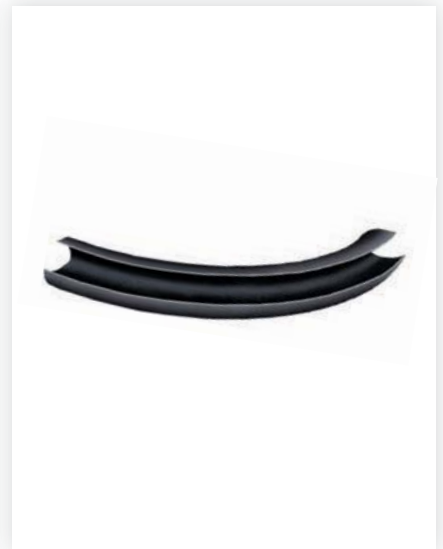

Bead repair segments

REMA TIP TOP is offering a selection of approved buffing tools for retreaders.

For detailed product information please view our online product catalogue at [→ http://products.rema-tiptop.com](http://products.rema-tiptop.com) or contact your REMA TIP TOP country representation. Our REMA TIP TOP Tool Catalogue presents many more tools. Available online: at the media center, on our website: [→ http://www.rema-tiptop.com](http://www.rema-tiptop.com).

SPECIAL MATERIAL FOR RETREADING

Special repair material for retreaders

EASY REPAIR GUM, free of CFC/aromatic compounds

- Quick repair of slightly injured envelopes already fitted on tyres to be cured
- Just apply the gum, allow to dry for a short time, then put the tyre with the envelope on it in the autoclave
- Removing the envelope from the tyre is not necessary, as the repair area is cured within the retreading cycle

Ref. No.	Description	Content
515 9073	EASY REPAIR GUM	100 g tin



515 9073

Envelope release agent

- High-quality envelope release agent
- Can be spread or sprayed
- Environmentally friendly, produced by our own high quality standards
- For application onto warm envelopes after each heating process
- Economic usage
- Effective and user-friendly

Ref. No.	Description	Content
593 1033	REMA TIP TOP SHE 100	5 l can
593 0773	REMA TIP TOP SHE 100	10 l can



593 1033

SPECIAL MATERIAL FOR RETREADING

Special repair material for retreaders

Envelope patches

- Repair patches for repairing both minor and larger injuries or for replacing damaged valves
- EASY REPAIR GUM is used for the application of these patches, providing a durable bond to the envelope
- Vulcanization takes place in a REMA TIP TOP Thermopress machine or in the autoclave



517 6609

Ref. No.	Description	Size	Content
517 6609	Envelope patches No. 5 for valves	94 mm	10
517 6537	Envelope patches No. 3	54 mm	30
517 6582	Envelope patches No. 7a	90 x 45 mm	30



517 6582

Envelope sidewall plates

- These plates help to retread tyre sidewalls in cold-retreading processes
- They are put on the freshly built-up sidewall under the envelope
- The build-up of spews on the sealing lip between the inner and the outer envelope is thus avoided
- The envelope sidewall plates, like envelopes, have to be treated with envelope release agent after use

Ref. No.	Description	Thickness	Size	Content	
517 6489	Sidewall plate size 1 Suitable for: Tyre size: 215/75 R 17.5"	3 mm	770 mm external	2	•
517 6496	Sidewall plate size 2 Suitable for: Tyre size: 275/70 R 22.5 and 315/60 R 22.5"	3 mm	970 mm external	2	•
517 6506	Sidewall plate size 3 Suitable for: Tyre size: 295/80 R 22.5"	3 mm	1040 mm external	2	•
517 6513	Sidewall plate size 4 Suitable for: Tyre size: 315/80 R 22.5 and 12 R 22.5"	3 mm	1160 mm external	2	•
517 6520	Sidewall plate size 5 Suitable for: Tyre size: 13 R 22.5"	3 mm	1100 mm external	2	•
517 6540	Sidewall plate size 6 Suitable for: Tyre size: 265/70R19.5"	3 mm	830 mm external	2	•
517 6550	Sidewall plate size 7 Suitable for: Tyre size: 285/70 R19.5"	3 mm	850 mm external	2	•

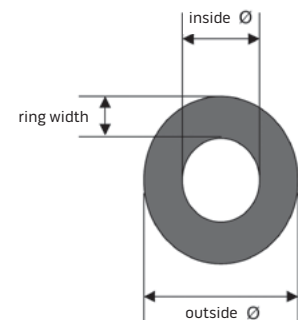

SPECIAL MATERIAL FOR RETREADING
Hand and cutting tools



Stitchers



Cleaning brushes

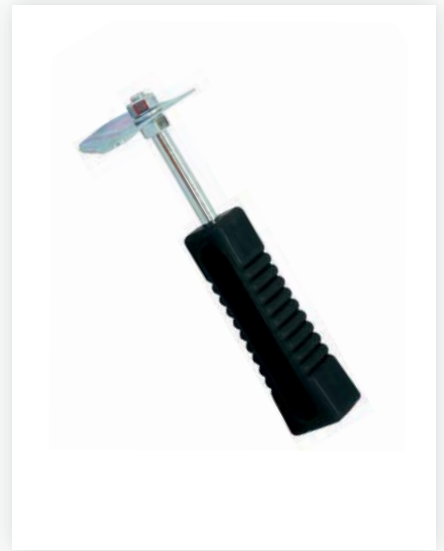

Tyre scrapers



Cutting tools



Rubber knives



Wetstones

REMA TIP TOP is offering a selection of approved hand and cutting tools.

For detailed product information please view our online product catalogue at
→ <http://products.rema-tiptop.com> or contact your REMA TIP TOP country representation.
Our REMA TIP TOP Tool Catalogue presents many more tools.
Available online: at the media center, on our website: → <http://www.rema-tiptop.com>.

SPECIAL MATERIAL FOR RETREADING
Measuring tools



Profil depth gauge



Hygrometer



Shore hardness
tester Shore A



Infrared radiation
thermometer



Pen piercing
thermometer



Digital
thermometer

REMA TIP TOP is offering a selection of approved measuring tools.

For detailed product information please view our online product catalogue at
→ <http://products.rema-tiptop.com> or contact your REMA TIP TOP country representation.
Our REMA TIP TOP Tool Catalogue presents many more tools.
Available online: at the media center, on our website: → <http://www.rema-tiptop.com>.

SPECIAL MATERIAL FOR RETREADING

Pneumatic tools



595 0234



595 0760



595 5583



595 0258



518 4206



595 0790

Air buffers

- For operations of rubber (low) or of the steel cord (high)
- Rear exhaust system with air inlet/outlet
- Safety lock throttle prevents accidental start-up
- Some units with cold-insulation cover or plastic insulation

Ref. No.	Description	Electric power/ connection	Rotating speed	Operating pressure	Power	Length	Weight
595 0234	Air buffer AIR SUPER (type PN) UT 8742 HMA, quick release (QR) chuck	1/4 Inch	0 - 4000 1/min	6.3 bar		190 mm	1.0 kg
518 4206	Air buffer SP 1523 KLSR, with drill chuck	1/4 Inch	0 - 3800 1/min	6.3 bar		200 mm	0.72 kg
595 5583	Air buffer AIR SUPER RC7078RED, with quick release (QR) chuck	1/4 Inch	0 - 3400 1/min	6.3 bar		200 mm	0.90 kg
595 0258	Air buffer UT 8721, with 6 mm collet chuck		0 - 22000 1/min.	6.2 bar	0.4 kW	175 mm	0.6 kg
517 2933	Air buffer CP 871, with drill chuck		0 - 22000 1/min.	6.2 bar	0.3 kW	210 mm	0.85 kg

Air buffers for retreading work

- These air buffers were specifically designed for tough continuous duty
- Thanks to their long shape they allow two-handed use, which reduces fatigue
- Low weight
- Plastic machine insulation
- Rear air exhaust

Ref. No.	Description	Rotating speed	Operating pressure	Size	Power	Weight
595 0790	Air buffer GP-0560SW, with hex quick-change chuck	0 - 3200 1/min	6.3 bar	345 x 48 L x W mm		1.33 kg
595 0760	Air buffer ST3TB mit 6mm collet chuck	0 - 22000 1/min.	6.2 bar		0.4 kW	1.2 kg

SPECIAL MATERIAL FOR RETREADING

Pneumatic tools



517 4450



517 3602



517 2847

Patch hammer

Facilitates the application of large, multi-ply repair patches to car, truck and EM tyres.

Ref. No.	Description	Electric power/ connection	Operating pressure	Weight	Content	Qty				
517 4450	Patch hammer, compact, with plastic ram	1/4 Inch	6 - 8 bar	1.0 kg	1	1	•	•		
517 3602	Patch hammer, large, with metal ram	1/4 Inch	6 - 8 bar	1.9 kg	1	1	•		•	•

Pneumatic fret saws

For removal of steel plies embedded within the rubber.

Ref. No.	Description	Rotating speed	Operating pressure	Weight	Content	Qty		
517 2847	Fret saw, pneumatic For the preparation of sidewall damages to truck tyres	9500 1/min	6.3 bar	0.65 kg	1	1	•	•

Vacuum cleaner for dust/water

For removal of dust and water from the tyre.

Ref. No.	Description	Intake volume	Length	Content	Qty		
519 7028	Vacuum cleaner for dust/water			1	1	•	•
519 7180	Vacuum cleaner for dust/water EM/OTR	5.0 l/min with 4 bar	340 mm	1	1		



519 7028



519 7180

Stapler

For the joining of tread splices when a tyre is retreaded.

Ref. No.	Description	Operating pressure	Content
518 4310	Tacker GT-8016X for staples of 12 mm width	5 - 6 bar	1
519 7170	Staple remover		1



518 4310

SPECIAL MATERIAL FOR RETREADING
Electric tools and accessories



Hand drills



Fret saw



Angle grinder



Impact wrenches



Screwdriver



Flexible shaft

REMA TIP TOP is offering a selection of approved of electric tools.

For detailed product information please view our online product catalogue at
→ <http://products.rema-tiptop.com> or contact your REMA TIP TOP country representation.
Our REMA TIP TOP Tool Catalogue presents many more tools.
Available online: at the media center, on our website: → <http://www.rema-tiptop.com>.

SPECIAL MATERIAL FOR RETREADING

Electric tools



595 1265, 595 1272,
595 1289



595 1356

Special buffing motors

- High-quality motors for driving shafts
- Modern, user-oriented motor technology for long life and improved safety
- High torque
- Motor brake prevents after-running of the tool - providing improved safety at work

Scope of delivery:

- 595 1356 incl. safety switch

- With suspension which can be integrated into existing carrying/rail systems
- All motors come with W 15 connection and can be adapted with adaptor 595 1295 for flexible shaft size W 12 if needed.

Required additional product:

- 1x Safety switch for hand shaft piece Ref. No. 595 1305 (exception: for article 5951356 VARIO POWER 3000, a safety switch is already included in delivery).

Ref. No.	Description	Rotating speed 1/min	Voltage	Power	Shaft	Content	Qty
595 1265	Buffing motor, low	1400	220/240 V	1.1/1.5 kW/PS	W 15	1	1
595 1272	Buffing motor, high	2800	220/240 V	1.1/1.5 kW/PS	W 15	1	1
595 1289	Buffing motor, two-speed	1400/2800	380/400 V	1.1/1.5 kW/PS	W 15	1	1
595 1356	Buffing motor VARIO POWER 3000	0 - 3100	220/240 V	1.1/1.5 kW/PS	W 15	1	1

SPECIAL MATERIAL FOR RETREADING

Electric tools



595 0382



595 0485



595 0416



595 0461



595 1305



595 1295



595 1381

Accessories - Special buffing motors

Ref. No.	Description	Content	Qty
595 0382	Flexible shaft W 10, rubber cover, approx. 2000 mm	1	1
595 0485	Flexible shaft W 12, rubber cover, approx. 2000 mm	1	1
595 0409	Flexible shaft W 12, metal cover, approx. 2000 mm	1	1
595 0492	Flexible shaft W 15, rubber cover, approx. 2000 mm	1	1
595 0416	Flexible shaft W 15, metal cover, approx. 2000 mm	1	1
595 0399	Spare inner shaft W 10	1	1
595 0423	Spare inner shaft W 12	1	1
595 0430	Spare inner shaft W 15	1	1
595 0911	Spare rubber cover W 12	1	1
595 0928	Spare rubber cover W 15	1	1
595 0447	Spare metal cover W 12	1	1
595 0454	Spare metal cover W 15	1	1
595 0461	Spare aluminium hand piece W 12/W 15	1	1
595 1295	Adapter Suitable for: Flexible shaft W 12 to shaft connection W 15 (motor)	1	1
595 1381	Mobile stand universal Suitable for: Buffing motors	1	1
595 1305	Safety switch for shaft hand piece Suitable for: All buffing motors with the exception of Vario Power 3000	1	1
595 1340	Safety switch POWER 3000 Suitable for: VARIO POWER 3000	1	1

SPECIAL MATERIAL FOR RETREADING Extruders



517 7490
517 7505





517 7512





517 5174
517 5175

Extruder NORMAL

- For quick filling of damages at all types of tyres
- Usable for all ropes of raw-rubber with 8 mm of diameter

Ref. No.	Description	Electric power/ connection	Rubber throughput	Operating pressure	Weight	Temperature range		
517 7490	REMA TIP TOP extruder NORMAL, pneumatic	115/550 V/W	18 kg/h	5 - 8 bar	5 kg	up to 120 °C	•	•
517 7505	REMA TIP TOP extruder NORMAL, pneumatic	230/550 V/W	18 kg/h	5 - 8 bar	5 kg	up to 120 °C	•	•

Extruder GIANT

Ref. No.	Description	Electric power/ connection	Rubber throughput	Operating pressure	Weight	Temperature range		
517 7512	REMA TIP TOP extruder GIANT	230/750 V/W	28 kg/h	5 - 8 bar	6 kg	up to 120 °C	•	•
517 5174	REMA TIP TOP extruder GIANT, electric Especially suitable for filling skives on EM tyres - High throughput allows quick filling of the skive	230/1600 V/W	40 kg/h		13 kg	up to 120 °C		•
517 5175	REMA TIP TOP extruder GIANT, electric Especially suitable for filling skives on EM tyres - High throughput allows quick filling of the skive	115/1600 V/W	40 kg/h		13 kg	up to 120 °C		•

SPECIAL MATERIAL FOR RETREADING Extruders



517 7608



517 5160
517 5150



517 3592

Extruder NAILHOLE

Ref. No.	Description	Electric power/ connection	Rubber throughput	Operating pressure	Temperature range	Content	Qty	
517 7608	REMA TIP TOP extruder NAILHOLE, pneumatic	230/400 V/W	6 kg/h	5 - 8 bar	up to 120 °C	1	1	

Extruder COMPOUND MASTER

- The effective hand extruder for easy processing of unvulcanized T2 COMPOUND in workshops or on site
- Sturdy A.C. drive unit
- Shoulder strap included
- Self-cooling aluminium housing for extruder worm
- Safe material supply thanks to large feeding hopper
- Extruder worm specifically designed for the application of T2 COMPOUND
- Homogeneous mixture ensured by integrated mixing chamber
- Quickly exchangeable jet moulding nozzle to shape the extruded material

Ref. No.	Description	Electric power/connection	Rubber throughput	Weight	Content	Qty
517 5160	REMA TIP TOP extruder COMPOUND MASTER	115/1600 V/W	24 kg/h	8.5 kg	1	1
517 5150	REMA TIP TOP extruder COMPOUND MASTER	230/1600 V/W	24 kg/h	8.5 kg	1	1
517 3592	Nozzle adapter set for COMPOUND MASTER				1	1

SPECIAL MATERIAL FOR RETREADING Marking / Branding



Marking with pen

For labelling rubber items or marking fields of repair patches.

Ref. No.	Description	Colour	Thickness	Content	Qty
595 0052	Patch marking pen	blue	0.6 mm F	10	1
595 0045	Marking pen silver	silver		1	1
595 0179	Rubber marking pen	white		5	1
595 0193	Refill for 595 0179	white		12	

Marking with chalk

For marking on tyre rubber - clearly visible.

Ref. No.	Description	Colour	Dia.	Content	Qty
595 0131	Lithografic marking chalk SISA	white	17 mm	12	1
595 0203	Lithografic marking chalk SISA	yellow	17 mm	12	1
595 8401	REMA TIP TOP tyre marker	rubber white	13 mm	12	1
595 8418	REMA TIP TOP tyre marker	yellow	13 mm	12	1
595 8449	Wax marking chalk	white	10 mm	20	1
595 8432	Wax marking chalk	yellow	10 mm	20	1
595 8460	Carmel special chalk, can also be used for marking on wet rubber	white	17.5 mm	12	1
595 8456	Chalk holder, for Wax marking chalk Ø 10 mm			1	1
595 8425	REMA TIP TOP metal holder, for REMA TIP TOP tyre marker Ø 13 mm			1	1
595 0227	Chalk holder SISA, for Lithografic marking chalk SISA Ø 17 mm			1	1

SPECIAL MATERIAL FOR RETREADING

Marking / Branding



519 0977

Letters and numbers
(for tyre marking)



519 0991



Tyre marking, electric

For branding of tyres. Special characters such as &, %, etc. available upon request.

Ref. No.	Description	Electric power/ connection	Size	Type size	Content	Qty
519 0977	Branding iron, 1 line	230/300 V/W	70 x 35 L x W mm	12 mm	1	1

Accessories - Tyre marking

Ref. No.	Description	Content	Qty	Ref. No.	Description	Content	Qty
519 0984	Complete set (letters A - Z)	26	1	558 7384	Letter S	1	1
519 0991	Complete set (numbers 0 - 9)	10	1	558 7391	Letter T	1	1
558 7195	Letter A	1	1	558 7401	Letter U	1	1
558 7205	Letter B	1	1	558 7418	Letter V	1	1
558 7212	Letter C	1	1	558 7425	Letter W	1	1
558 7229	Letter D	1	1	558 7432	Letter X	1	1
558 7236	Letter E	1	1	558 7449	Letter Y	1	1
558 7243	Letter F	1	1	558 7456	Letter Z	1	1
558 7250	Letter G	1	1	558 7463	Number 1	1	1
558 7267	Letter H	1	1	558 7470	Number 2	1	1
558 7274	Letter I	1	1	558 7487	Number 3	1	1
558 7281	Letter J	1	1	558 7494	Number 4	1	1
558 7298	Letter K	1	1	558 7504	Number 5	1	1
558 7315	Letter L	1	1	558 7511	Number 6	1	1
558 7322	Letter M	1	1	558 7528	Number 7	1	1
558 7339	Letter N	1	1	558 7535	Number 8	1	1
558 7346	Letter O	1	1	558 7542	Number 9	1	1
558 7353	Letter P	1	1	558 7559	Number 0	1	1
558 7360	Letter Q	1	1	558 7170	Special character (+)	1	1
558 7377	Letter R	1	1	558 7160	Special character (-)	1	1

SPECIAL MATERIAL FOR RETREADING Marking / Branding



Aluminium labels

- Aluminium labels can be applied for tyre marking during retreading/hot-vulcanizing process
- Spaces on metal labels are counted as characters
- Orders of less than 250 labels cannot be processed

Coloured labels of printed rubber are available upon request! Please fill-in a separate order form.

Ref. No.	Description	Size
599 3239	Aluminium label (ECE) 4mm, font height Aluminium ECE label with KBA number - Normal font 12/6/4 - One line, recessed - Text: (E1) 109R-000750	60 x 16 x 0.2 mm
599 3246	Metal label (text) 8 mm, font height Aluminium text labels - Raised characters - Any text with max. 18 letters or numbers in one line	text x 12 x 0.2 mm
599 3332	Metal label (numbers) 8 mm, font height 3 characters can be added (before or after the number) at the customer's request - Aluminium text labels - Raised characters - Max. 12 letters or numbers in one line	68 x 12 x 0.2 mm
599 3208	Metal label (Retread KW) 8 mm, font height Week labels in conformity with ECE standard aluminium text labels - Recessed characters - Max. 11 letters or numbers in one line - Example: RETREAD 2508	82 x 12 x 0.2 mm
599 3215	Metal label (Retread KW XXX) 8 mm, font height 3 additional characters can be added at the customer's request - Week labels in conformity with ECE, long - Aluminium text labels - Recessed characters - Max. 11 letters or numbers in one line	103 x 12 x 0.2 mm
599 3222	Metal label (KW) 8 mm, font height Week labels without RETREAD, short - Aluminium text labels - Recessed characters - Max. 4 numbers in one line	35 x 12 x 0.2 mm
599 3190	Metal label (blank) Aluminium text labels - Recessed characters	35 x 12 x 0.2 mm
599 3277	Metal label (TEXT) 8 mm, font height Aluminium text labels - Raised characters - Max. 5 letters or numbers in one line - Example: M+R (maximum 3 letters)	40 x 12 x 0.2 mm



TOOLS FOR TYRE HANDLING/SERVICE

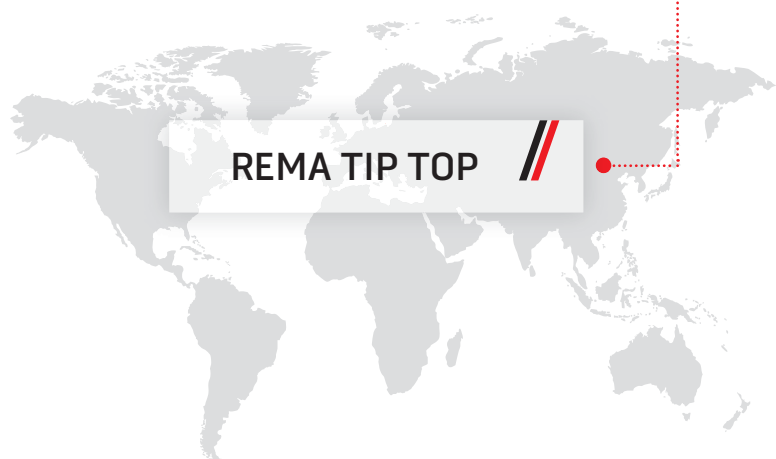

REMA TIP TOP



Regrooving

80-81

Lighting

82-83

Tyre spreaders

84-87

Bead brakers

88-91

3

TOOLS FOR TYRE HANDLING/SERVICE

Regrooving



RUBBER CUT 314



RUBBER CUT 414

RUBBER CUT 314

- For regrooving all tread patterns on commercial vehicle tyres
- 4-step temperature switch on main transformer for different cutting speeds
- Handle with separate transformer enables fatigue-free handling
- Flexible connection cable for optimum movability of the handle
- Most advanced safety technology with all approval seals
- Cutting width with FIX regrooving blades 3 - 28 mm

Ref. No.	Description	Electric power/ connection	Length	Weight	Tempera- ture range	Content	Qty	
564 1210	RUBBER CUT 314 115 V	115/300 V/W	1600 mm connection	3.8 kg	4 heat settings	1	1	•
564 1200	RUBBER CUT 314 230 V	230/300 V/W	1600 mm connection	3.8 kg	4 heat settings	1	1	•

RUBBER CUT 414

- Ergonomic design for fatigue-proof regrooving
- 4-step temperature switch on main transformer with MIN/MAX-selector allows 8 heating levels for different cutting speeds
- Automatic overheating cutout according to DIN 30600
- Insulated cutting head
- Greater freedom of movement and easy guiding due to separation of handle and transformer
- Cutting width with FIX regrooving blades 3 - 28 mm
- Prepared for wall mounting
- GS-tested, meets recognized safety standards

Ref. No.	Description	Electric power/ connection	Length	Weight	Tempera- ture range	Content	Qty	
564 1230	RUBBER CUT 414 115 V	115/300 V/W	1600 mm connection	3.8 kg	8 heat settings	1	1	•
564 1220	RUBBER CUT 414 230 V	230/300 V/W	1600 mm connection	3.8 kg	8 heat settings	1	1	•

TOOLS FOR TYRE HANDLING/SERVICE

Regrooving

Cutting knife for regroovers

- Perfect cutting performance
- Long service life
- One-sided polished section for ideal steering in rubber
- R Fix = round blade
- W Fix = angle blade

Please observe the local directives on the regrooving of commercial vehicle tyres!

Ref. No.	Description	Cutting width	Cutting depth	Content	Qty	
564 2803	R Fix 1	3 - 4 mm	max. 7 mm	20	1	•
564 2810	R Fix 2	5 - 6 mm	max. 8 mm	20	1	•
564 2827	R Fix 3	6 - 8 mm	max. 10 mm	20	1	•
564 2834	R Fix 4	9 - 10 mm	max. 14 mm	20	1	•
564 2841	R Fix 5	10 - 14 mm	max. 16 mm	20	1	•
564 2858	W Fix 1	3 - 4 mm	max. 7 mm	20	1	•
564 2865	W Fix 2	5 - 6 mm	max. 8 mm	20	1	•
564 2872	W Fix 3	6 - 8 mm	max. 10 mm	20	1	•
564 2889	W Fix 4	9 - 10 mm	max. 14 mm	20	1	•
564 2896	W Fix 5	10 - 14 mm	max. 16 mm	20	1	•
564 2906	W Fix 6	22 - 28 mm	max. 16 mm	10	1	•



Profile cutter blade

RUBBER CUT STATION ECO

- Tool stand and gauge for easy regrooving of truck tyres 17.5" - 24.5"
- Tyres can be regrooved on or off their rims
- Efficient working and loading/unloading of the tyres
- Low space requirement, secure holding of tyres
- Integrated setting gauge
- One roller is equipped with a brake preventing accidental tyre rotation
- Equipped with two castors for moving around workshop
- Rubber Cut tool not included in standard shipment

Ref. No.	Description	Size	Weight
518 3719	RUBBER CUT STATION ECO Suitable for: Wheel width max. 500 mm	1100 x 1100 x 1150 L x W x H mm	approx. 40 kg



518 3719

TOOLS FOR TYRE HANDLING/SERVICE

Lighting



LED-TECHNOLOGY

Lighting

The right light for every Job.

Ref. No.	Description	Electric power/ connection	Content	Qty				
595 3028	Tyre inspection lamp, without holder Suitable for: Tyre widths from 5.5 to 18"	220/8 V/W	1	1	•	•	•	•
595 3011	Holder for Tyre inspection lamp Suitable for: 595 3028		1	1	•	•	•	•
517 4522	Halogen lamp, magnetic	220+12/20 V/W	1	1	•	•	•	•
517 4560	LED illuminant, 460 lumens Suitable for: 517 4522	12/6 V/W	1	1	•	•	•	•
571 9520	Working light OPUS I	220/11 V/W	1	1	•	•	•	•
594 0910	Flexarm 500 mm magnetic clamp Suitable for: 571 9520		1	1				

Working light NOVA

- New and strong 30 W COB work light designed with state-of-art LED technology for the professional user
- The new COB LEDs provide a unique, powerful and absolutely uniform illumination, which makes this an ideal working light for use in tyre repair, especially for large tyres.

- Sturdy body made of aluminium, in slim and elegant design
- The lamp is very solid and shockproof
- Cable: 5 m (3 x 1.5 mm)
- Protection class IP 67 allows the use under open sky

Ref. No.	Description	Electric power/ connection	Power	Content	Qty
595 2260	Work light NOVA	220/30 V/W	2400 Lumen LED	1	1

TOOLS FOR TYRE HANDLING/SERVICE

Lighting





571 9740



571 9750

Working light Light-Master

- This series was designed especially for professional use in demanding workshop environments
- The Light-Master is brilliant for providing lighting to tractor/OTR tyres when carrying out repairs
- Safe and simple handling
- Very low heat dissipation
- Low energy consumption
- Quickly replaceable branded fluorescent tube
- Tough rubber-tyred castors ensure good motion of the stand
- Telescopic rail provides wide action radius
- Horizontal multiple locking capability for individual adjustments
- Stable stand thanks to cast-iron base of approx. 30 kg
- Practical use: two additional sockets for connection of further electrical devices
- Flexible connection cable, oil and petrol resistant
- Lights approved according to EN 60598-2-8 and EN 55015, and EN 60598-2-1

Ref. No.	Description	Electric power/connection	Content	Qty		
571 9740	Light-Master 2, with base and telescopic rail	220/2 x 24 V/W	1	1	•	•
571 9750	Light-Master 2, with additional socket, without base	220/2 x 24 V/W	1	1	•	•

More energy efficient LED technology workshop lighting on request. Consultation at your premises available!
High energy saving potential leads to the minimisation of energy costs and that way amortisation of switching costs within the shortest time!

TOOLS FOR TYRE HANDLING/SERVICE

Tyre spreaders



517 8092



595 2988



595 2971



519 9222,
519 8780

Tyre spreaders

- Tyre spreaders for preparing the inspection and repair of truck and car tyres
- High stability and strength
- Easy operation
- Wide spreading range
- Suitable for very stiff beads

Ref. No.	Description	Spreading range	Operating pressure	Size	Tyre size	Weight						
517 8092	Fire hose tensioner Holds the hose and provides a smooth base for vulcanizing of high-pressure hoses											
595 2988	Tyre/tube tensioner Can fix tubes, car and motorcycle tyres - Can be mounted on work bench						•	•				
595 2971	Car tyre spreader For easy spreading of tyre beads (two required)						•	•				
519 8780	Truck tyre spreader, with clamping mechanism	50 - 600 mm		770 x 200 x 90 L x W x H mm		4.4 kg			•	•		
519 9222	EM tyre spreader, with clamping mechanism	100 - 530 mm		937 x 466 x 120 L x W x H mm		9.0 kg					•	•

TOOLS FOR TYRE HANDLING/SERVICE
Tyre spreaders



517 6984



519 9181



517 6991



519 9239

Ref. No.	Description	Spreading range	Operating pressure	Size	Tyre size	Weight					
517 6984	Truck tyre spreader, pneumatic	100 - 350 mm	6 - 8 bar			approx. 4.4 kg			•	•	
519 9181	EM bead spreader, hydraulic Hydraulic bead spreader for EM tyres with stiff beads - Pump not included in standard shipment Suitable for: Hand/foot pump hydraulic; Foot pump pneumatic-hydraulic	200 - 1150 mm	500 bar		20 - 57 Inch	42 kg					•
517 6991	Spreader bars, truck For securing spreaded tyre beads	230 - 360 mm				1.2 kg			•		
519 9239	EM Spreader bars For securing spreaded tyre beads	340 - 550 mm				6 kg					•

TOOLS FOR TYRE HANDLING/SERVICE

Tyre spreaders



REP BOY tyre spreader
(tyre, lamp and base plate
not included)



REPMAT
(tyre not included)

REP BOY tyre spreader

- Tyre spreader for preparing the inspection and repair of car and motorcycle tyres
- The tyre can be inspected and prepared inside and outside
- The tyre can be turned and inclined into the perfect working position (patented mechanism)
- Comfortable working height
- Integrated tray for tools and materials
- Halogen lamp and base plate not included but separately available

Ref. No.	Description	Weight		
517 0777	REP BOY tyre spreader, mechanical	26 kg	•	•
517 0784	Base plate for REP BOY tyre spreader	14 kg		

REPMAT tyre spreader

- Tyre spreader for preparing the inspection and repair of car and truck tyres
- Compact, light weight construction
- Operating pressure controlled by hand lever
- The tyre is rolled into position up a detachable ladder
- Comfortable working height

Ref. No.	Description	Operating pressure	Size	Overall height	Working height	Weight		
518 3506	REPMAT tyre spreader, pneumatic	10 bar	800 x 500 W x H mm	700 mm	510 mm	45 kg	•	•

TOOLS FOR TYRE HANDLING/SERVICE

Tyre spreaders



Tyre lift spreader
RHS 300-2



519 9210, 570 1510



570 1500



570 1530



570 1540



570 1550

570 1660



570 1650, 570 1520



Tyre lift spreader RHS 300-2

- For preparing the inspection and repair of agricultural, truck, EM and industrial tyres
- For tyres with a max. of 1700 mm outer diameter up to 300 kg at 10 bar/145 PSI operating pressure
- Unique table tilt range of 0 to 40 degrees

(fixation on the floor is required)

- Shoulder and sidewall repairs can be carried out ergonomically
- Low roll-on height of 280 mm
- Optimised lifting height up to 880 mm
- Clearly arranged controls

Optional accessories (see item list below)

Ref. No.	Description	Tyre size	Lifting height	Size	Weight			
519 9210	Tyre lift spreader RHS 300	up to 520/60 R38	880 mm	1380 x 800 x 1520 H x W x L mm	235 kg	•	•	•
519 9167	Set of EM extensions Suitable for: Tyre lift spreader RHS 300; Tyres up to 23.5R25				3.9 kg		•	
570 1500	Tool tray							
570 1510	Slide							
570 1650	Maintenance unit, complete, up to 16 bar, consisting of compressed air filter/oiler assembly					•	•	
570 1540	Ramp RHS 300					•	•	
570 1520	Compressed air bar, 4 ports							
570 1550	Supporting rod for large-size tyres					•		
570 1530	Multi-socket power strip, 4 outlet							
570 1660	Mounting kit for servicing unit							

TOOLS FOR TYRE HANDLING/SERVICE

Bead breakers

EM mounting set

- Suitable for demounting and mounting EM tyres, also on the vehicle
- The mounting set is used to press off the rings of multi-piece rims
- The mounting set can also be used in case of inflation problems
- The flange ring is then pressed against the sealing ring/tyre bead until the tyre is sufficiently pressurized



519 1582

Scope of delivery:

- 2 Threaded spindles with claw 440 mm
- 2 Threaded spindles with bracket 400 mm
- 2 Tyre levers, different length
- 1 Spanner



519 1567

Ref. No.	Description	Size	Bead Breaking force	Weight	
519 1582	EM mounting set, 25" - 38" Base frame in wooden box, without the pump	1200 x 500 x 220 L x W x H mm			•
519 1550	Extension set, 39" - 51", for EM mounting set Includes 1x extension frame, 1x extension spindle, 1x nut M 24, 1x nut M 12, 1x bolt M 12				•
519 1567	Bead breaking cylinder, with adjusting cylinder for inside breaking		500 bar	8 kg	•

EM bead breaker STANDARD

- The EM bead breaker 23" - 49" is suitable for EM tyres on 5-piece rims
- Not damaging to the beads
- As a rule, the tyres are demounted on-vehicle
- Pump not included in standard shipment



519 1598

Ref. No.	Description	Bead Breaking force	Weight	Tyre size	
519 1598	EM bead breaker STANDARD for hand/-foot pump hydraulic, foot pump air-hydraulic	500 bar	15 kg	23 - 49 Inch	•

TOOLS FOR TYRE HANDLING/SERVICE

Bead brakers

EM bead breaker GIGANT I

- The EM bead breaker is suitable for EM tyres on 5-piece rims
- Not damaging to the beads
- As a rule, the tyres are demounted on-vehicle
- Pump not included in standard shipment

Scope of delivery:

- 558 9234 1 Adjustable counter-support
- 558 6440 1 Counter support 49"
- 558 6749 1 Puller hook size 2
- 558 9227 1 Puller hook size 19
- 1 Insert segment, height 20, 30, 40, 50 mm

Ref. No.	Description	Bead Breaking force	Weight	Tyre size	
519 1725	EM bead breaker GIGANT I	700 bar	30 kg	23 - 49 Inch	• 



519 1725

EM bead breaker GIGANT II

- The EM bead breaker is suitable for EM tyres on 5-piece rims
- Not damaging to the beads
- As a rule, the tyres are demounted on-vehicle
- Dual drawing hook mechanism for use on a balancer/suspension device
- Pump not included in standard shipment

Scope of delivery:

- 558 6457 1 Counter-support 51"
- 1 Adjustable counter-support
- 1 Insert segment, height 17, 25, 40 mm

Ref. No.	Description	Bead Breaking force	Weight	Tyre size	
519 1677	EM bead breaker GIGANT II	700 bar	70 kg	51 - 57 Inch	• 
519 1684	Carriage, for EM bead breaker GIGANT II				•
558 6464	Counter-support 57", for EM bead breaker GIGANT II				•



519 1677

For further bead brakers please visit our online product catalogue at
 → <http://products.rema-tiptop.com> or contact your REMA TIP TOP country representation.
 REMA TIP TOP Tool Catalogue presents many more tools.
 Available online: at the media center, on our website: → <http://www.rema-tiptop.com>.



TOOLS FOR TYRE HANDLING/SERVICE

Bead brakers



Bead breaker

Hydraulic claw breaker for breaking the beads on mounted or demounted wheels.

Ref. No.	Description	Bead Breaking force	Weight	Content	Qty			
519 1574	Bead breaker AS For combi-ring rims and four-piece flat base rims of truck wheels, AS-, grader- and EM-tyres on three-piece semi drop centre rims with locking ring and one-piece drop centre rims for forklifts and Unimog. Pump not included.	500 bar	22 kg	1	1	•	•	
519 1731	OTR EM bead breaker type 3 light For three-piece OTR-/EM-wheels without groove in bead area. High breaking force and reliable techniques. Pump not included.	700 bar	18 kg	1	1			•
558 2620	Bead breaking jaw type 3, up to 25" Suitable for: OTR EM bead breaker type 3			1	1			•
558 2630	Bead breaking jaw, standard Suitable for: OTR EM bead breaker type 3			1	1			•
558 2640	Bead breaking jaw short, up to 2" Suitable for: OTR EM bead breaker type 3			1	1			•
558 2660	Bead breaking jaw long, up to 3"			1	1			
558 2650	Spare support legs Suitable for: OTR EM bead breaker type 3			1	1			•
558 2668	Bead breaking finger straight The straight finger is required for bead breaking on the inside of the vehicle - For vehicles such as VOLVO L90C, L110C, 120C, 180F or LIEBHERR L544, L 564, L 574 with little space between wheel hub and rim, which makes it impossible to use the standard bead breaking jaw Suitable for: OTR EM bead breaker type 3			1	1			•

TOOLS FOR TYRE HANDLING/SERVICE

Bead brakers



519 1512, 519 1513



519 1520





519 1529



519 1691

Pumps

Hydraulic pumps for bead brakers.

Ref. No.	Description	Electric power/ connection	Bead Breaking force	Size	Weight	Con- tent	Qty		
519 1512	Hand/foot pump, hydraulic Suitable for: Wheel/tyre remover		500 bar			1	1	•	•
519 1513	Hand/foot pump, hydraulic Suitable for: OTR EM bead breaker type 3		700 bar			1	1		•
519 1529	Foot pump, pneumatic-hydraulic Suitable for: Wheel/tyre remover		500 bar			1	1	•	•
519 1520	Foot pump, pneumatic-hydraulic Pneumatic assistance speeds up pumping - Foot switch with 2 positions (pump/release) Suitable for: OTR EM bead breaker type 3	1/4 Inch for air	700 bar	295.5 x 112 x 172 L x W x H mm	5.3 kg	1	1		•
519 1691	Foot pump, pneumatic-hydraulic For bead brakers with large oil volume such as the „GIGANT“ series Suitable for: EM bead breaker GIGANT I ; EM bead breaker GIGANT II		700 bar			1	1		•

For further bead brakers please visit our online product catalogue at
 → <http://products.rema-tiptop.com> or contact your REMA TIP TOP country representation.
 REMA TIP TOP Tool Catalogue presents many more tools.
 Available online: at the media center, on our website: → <http://www.rema-tiptop.com>.



VULCANIZING MACHINES AND ACCESSORIES

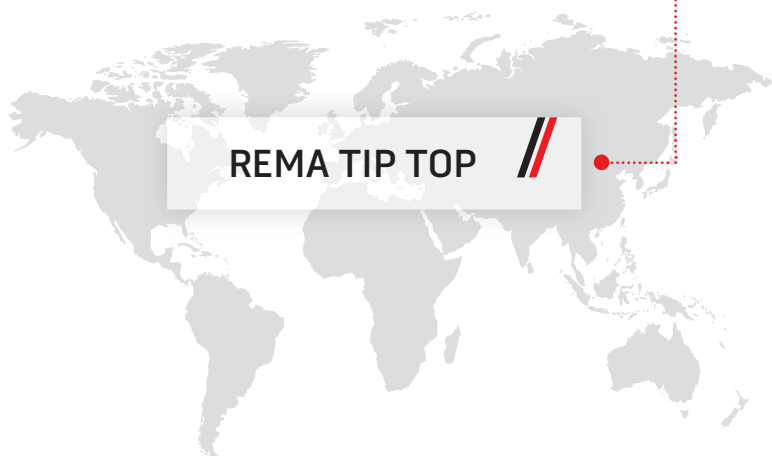

REMA TIP TOP



Thermopress 2-step repair systems	94-101
Thermopress accessories	102-103
1-step repair systems	104-108
Equipment for working places	109-110

VULCANIZING MACHINES AND ACCESSORIES

Thermopress 2-step repair systems

Thermopress DUPLEX



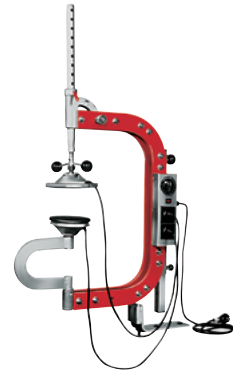

- For the economic repair from car tyres to agri tyres
- Most minor injuries in radial and cross-ply tyres can be repaired in a short time
- Repairs small rubber injuries and tears in the fabric fast and professional
- Vulcanizing temperature of approx. 160° C (320° F)

Scope of delivery:

- 517 3570 2 Heating plates
- 517 7048 1 Timer unit 0 - 120 min
- 517 1295 1 U-clamp
- 517 2438 1 Pressure equalizing pad 180 x 130 mm
- 581 1990 1 User's manual



517 7000

Ref. No.	Description	Electric power/ connection				
517 7017	Thermopress DUPLEX	120/600 V/W	•	•	•	•
517 7000	Thermopress DUPLEX	230/600 V/W	•	•	•	•

VULCANIZING MACHINES AND ACCESSORIES

Thermopress 2-step repair systems

Thermopress TP II

- For economic repairs of all type of tyres
- Most minor injuries in radial and cross-ply tyres can be repaired in a short time
- Vulcanizing temperature of approx. 160° C (320° F)

Scope of delivery:

- 517 3570 2 Heating plates
- 517 1295 1 U-clamp
- 517 3248 1 Extension for heating plate
- 517 1941 1 Set of pressure equalizing pads
- 517 7172 1 Rubber cover for car tyres
- 517 7165 1 Rubber cover for truck tyres
- 517 7158 1 Heating plate cover, truck, top
- 517 2294 1 Base plate
- 581 1560 1 User's manual



517 1525

Ref. No.	Description	Electric power/ connection	Operating pressure					
517 1525	Thermopress II ECONOMY	230/540 V/W		•	•	•	•	•
517 3531	Thermopress II PNEUMATIC	230/600 V/W	6 - 10 bar	•	•	•	•	•
517 1532	Thermopress II ECONOMY	120 V		•	•	•	•	•



517 3531

Digital extension - Thermopress

- For individual temperature control of the heating plates
- Especially suitable for cosmetic repairs in tyre production and retreading
- Optional for all Thermopress II machines
- Illuminated I/O mains switch
- Separate fuse for each heating plate/heating circuit
- Temperature controller with digital display from 0 to 200 °C (32 to 392 °F)
- Mounting clamp (on back of housing)

Ref. No.	Description	Electric power/ connection					
517 4150	Digital control TP II Suitable for: Thermopress II PNEUMATIC; Thermopress II ECONOMY	230/600 V/W	•	•	•	•	•
517 4030	Heating plate digital Suitable for: Thermopress II ECONOMY 230 V (2 pcs. required) Thermopress II from year of manufacture: 2013	230/600 V/W	•	•	•	•	•



Digital control unit and heating plates



517 4150

VULCANIZING MACHINES AND ACCESSORIES

Thermopress 2-step repair systems



517 3891



517 1130



517 1123



Support stand TP II SHUTTLE



Support stand - Thermopress

- Easier use of the Thermopress machines
- Support stands can be floor-mounted
- Ergonomic working height

Ref. No.	Description	Content	Qty					
517 3884	Table support clamp Suitable for: Thermopress JUNIOR; Thermopress DUPLEX	1	1					
517 2294	Base plate Suitable for: Thermopress II PNEUMATIC; Thermopress II ECONOMY; Thermopress Tube-P	1	1					
517 3891	Support stand Suitable for: Thermopress JUNIOR; Thermopress DUPLEX	1	1	•	•			
517 1130	Support stand, floor-mounted Support stand for easier working on the tread area of car, van and truck tyres - Includes shelves for storage of small items Suitable for: Thermopress II PNEUMATIC; Thermopress II ECONOMY; Thermopress Tube-P	1	1	•	•	•		
517 1123	Support stand PNEUMATIC Allows easy lifting and lowering of the machine and tyre with a pneumatic system - Two rollers at the base allow tyres to be easily turned into the repair position Suitable for: Thermopress II PNEUMATIC; Thermopress II ECONOMY	1	1	•	•	•		
517 4900	Support stand Thermopress II SHUTTLE Mobile support for all Thermopress II ECONOMY and PNEUMATIC vulcanizing machines - Makes it easy to clamp light truck, truck, agricultural and EM tyres for tread, shoulder or sidewall repairs - Vertically adjustable - Can be swivelled - Four castors (two with integrated stop) - Spacious tool tray - Retaining straps 2 and 3 are included Suitable for: Thermopress II PNEUMATIC; Thermopress II ECONOMY	1	1	•	•	•	•	•

VULCANIZING MACHINES AND ACCESSORIES

Thermopress 2-step repair systems



517 7701

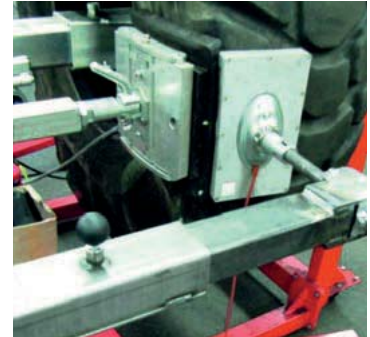

517 7710

Thermopress EM I

Hot vulcanizing machine for repairing tread, shoulder or sidewall injuries of radial, cross-ply OTR/EM tyres, with the use of REMA TIP TOP repair patches.

- Sturdy construction provides easy maintenance and a long service life
- Adaptation to every repair position by a built-in tilting and swivelling mechanism
- Electronic temperature controller with display is integrated

- Upper parts of frame zinc-plated
- Electronic temperature control with digital temperature display for each heating plate
- Electronic curing time control, from 0 to 99 hours
- Pneumatic pressure system, max. pressing power approx. 3 tons at 8 bar (115 PSI)
- Equipped with counter for operating hours

Scope of delivery:

- 1 Mobile undercarriage
- 1 Energy block/control unit
- 1 Complete frame
- 2 Pressure plates

- 517 6001 1 Thermopress EM heating plate No. 1
- 517 6025 1 Thermopress EM heating plate No. 2
- 1 set of different slip-on contour segments
- User's manual
- EM-, truck tyre adapters are not included in delivery

Voltage	230 V
Operating pressure	4 - 8 bar
Curing temperature	approx. 175 °C
Size	2550 x 2110 x 1170/1370 L x W x H mm
Weight	270 kg

Ref. No.	Description	Content	Qty			
517 7701	Thermopress EM I, pneumatic for EM tyres up to size 33.25-35	1	1	•	•	•
517 7710	Additional pressure arm with a third heating plate for shoulder repairs of EM tyres	1	1		•	•

VULCANIZING MACHINES AND ACCESSORIES

Thermopress 2-step repair systems



517 5002



517 5727

Thermopress EM II

Hot vulcanizing machine for repairing tread, shoulder or sidewall injuries of radial, cross-ply OTR/EM tyres, with the use of REMA TIP TOP repair patches.

- Universal frame adjustment, suitable for the repair of radial and cross-ply tyres up to size 30.00-51 in the basic version
- Electronic temperature controller with digital display of actual and desired temperature

- Upper parts of frame zinc-plated
- Electronic temperature control with digital temperature display for each heating plate
- Electronic curing time control, from 0 to 99 hours, equipped with counter for operating hours

Scope of delivery:

- 1 Mobile undercarriage
- 1 Energy block/control unit
- 1 Complete undercarriage
- 3 Pressure plates

- 517 6025 1 Thermopress EM heating plate No. 2
- 517 6032 1 Thermopress EM heating plate No. 3
- 1 set of different slip-on contour segments
- User's manual

Voltage	230 V
Operating pressure	max. 160 bar
Curing temperature	approx. 175 °C
Size	2600 x 2500 x 1770 L x W x H mm
Weight	459 kg

Ref. No.	Description	Content	Qty	
517 5002	Thermopress EM II, electro-hydraulic	1	1	•
517 5727	Thermopress EM accessory GIGANT, for EM tyres up to 40.00-57" includes 1x Frame slip-on adapter, 1x Retaining bolt dia = 20 mm, 1x Retaining tube 50 x 280 mm, 1x Heating plate support short 80 x 435 mm, 1x Heating plate support medium 80 x 645 mm, 1x Heating plate support long 80 x 1005 mm Suitable for: Thermopress EM II	1	1	•
517 5253	Extension cable 2.5 m Suitable for: Thermopress EM II	1	1	

VULCANIZING MACHINES AND ACCESSORIES

Thermopress 2-step repair systems



517 7804

Thermopress EM III

Hot vulcanizing machine for repairing tread, shoulder or sidewall injuries of radial, cross-ply OTR/EM tyres, with the use of REMA TIP TOP repair patches.

- For the repair of large EM tyres from 30.00-51 to 67.5/60-51 and 54.00 using REMA TIP TOP OTR/EM repair patches
- Mobile construction with universal tilt-and-swivel frame
- Digital instrumentation and electronic control ensure the right pressure, temperature and cure time
- Can also be connected to 230 V

- Upper parts of frame zinc-plated
- Electronic temperature control with digital temperature display for each heating plate
- Electronic curing time control, from 0 to 99 hours
- Hydraulic pressure system with resetting device
- Equipped with counter for operating hours

Scope of delivery:

- 1 Mobile undercarriage
- 1 Energy block/control unit
- 1 Complete frame
- 2 Pressure plates

- 517 6032 1 Thermopress EM heating plate No. 3
- 517 6252 1 Thermopress EM heating plate No. 4
- 1 set of different slip-on contour segments
- 1 User's manual

Voltage	380 V
Operating pressure	max. 160 bar
Curing temperature	approx. 175 °C
Size	3300 x 3300 x 2900 mm L x W x H
Weight	1300 kg

Ref. No.	Description	Content	Qty	
517 7804	Thermopress EM III, electrohydraulic	1	1	•

VULCANIZING MACHINES AND ACCESSORIES

Thermopress 2-step repair systems

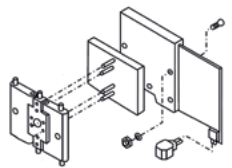

517 6001

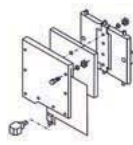

517 6025

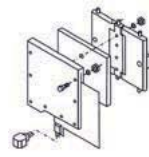

517 6032



517 6040



517 5215



517 5222



517 5239



517 5246



517 5260

Thermopress EM heating plate

Complete with heating mat and heating pocket.

Ref. No.	Description	Size	Content	Qty			
517 6001	Thermopress EM heating plate No. 1 Suitable for: Thermopress EM-I; Thermopress EM-II	approx. 230 x 230 mm	1	1	•	•	•
517 6025	Thermopress EM heating plate No. 2 Suitable for: Thermopress EM-I; Thermopress EM-II	approx. 330 x 330 mm	1	1	•	•	•
517 6032	Thermopress EM heating plate No. 3 Suitable for: Thermopress EM-II; Thermopress EM-III	approx. 430 x 430 mm	1	1		•	
517 6252	Thermopress EM heating plate No. 4 Suitable for: Thermopress EM-II; Thermopress EM-III	approx. 530 x 530 mm	1	1		•	
517 6040	Thermopress EM heating plate No. 5 Suitable for: Thermopress EM III	approx. 750 x 550 mm	1	1		•	

Thermopress EM heating mats

Note on maintenance:

The life of the EM heating mat can be considerably prolonged by powdering it with talcum before every use.

Ref. No.	Description	Electric power/ connection	Size	Content	Qty			
517 5215	Thermopress EM heating mat size 1 Suitable for: Thermopress EM-I; Thermopress EM-II	350 W	190 x 190 mm	1	1	•	•	•
517 5222	Thermopress EM heating mat size 2 Suitable for: Thermopress EM-I; Thermopress EM-II	450 W	265 x 265 mm	1	1	•	•	•
517 5239	Thermopress EM heating mat size 3 Suitable for: Thermopress EM-II; Thermopress EM-III	800 W	365 x 365 mm	1	1		•	
517 5246	Thermopress EM heating mat size 4 Suitable for: Thermopress EM-II; Thermopress EM-III	1100 W	450 x 470 mm	1	1		•	
517 5260	Thermopress EM heating mat size 5 Suitable for: Thermopress EM III	2000 W	735 x 545 mm	1	1		•	

VULCANIZING MACHINES AND ACCESSORIES

Thermopress 2-step repair systems

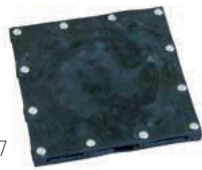

517 6207



517 5033



Thermopress EM heating pockets

Ref. No.	Description	Size	Content	Qty			
517 6207	Thermopress EM heating pocket size 1 Suitable for: Thermopress EM-I; Thermopress EM-II	230 x 230 x 18 mm	1	1	•	•	•
517 5033	Thermopress EM heating pocket size 2 Suitable for: Thermopress EM-I; Thermopress EM-II	330 x 330 x 35 mm	1	1	•	•	•
517 5040	Thermopress EM heating pocket size 3 Suitable for: Thermopress EM-II; Thermopress EM-III	455 x 430 x 35 mm	1	1		•	
517 6276	Thermopress EM heating pocket size 4 Suitable for: Thermopress EM-II; Thermopress EM-III	555 x 530 x 35 mm	1	1		•	
517 5961	Thermopress EM heating pocket size 5 Suitable for: Thermopress EM III	810 x 645 x 35 mm	1	1		•	

Thermopress EM pressure-equalizing pads

Ref. No.	Description	Size	Content
517 6214	Thermopress EM pressure pad, size 1	200 x 185 x 30 L x W x H mm	1
517 5057	Thermopress EM pressure pad, size 2	295 x 245 x 30 L x W x H mm	1
517 5064	Thermopress EM pressure pad, size 3	395 x 345 x 30 L x W x H mm	1
517 6283	Thermopress EM pressure pad, size 4	495 x 445 x 30 L x W x H mm	1
517 6290	Thermopress EM pressure pad, size 5	740 x 550 x 40 L x W x H mm	1

Accessories - Thermopress EM

Ref. No.	Description	Size	Content
557 3219	Aluminium contour plate, curved Suitable for: Thermopress EM heating plate No. 1	250 x 250 x 2 L x W x H mm	1
557 8836	Aluminium contour plate, straight Suitable for: Thermopress EM heating plate No. 2	300 x 300 x 2 L x W x H mm	1
557 3226	Aluminium contour plate, straight Suitable for: Thermopress EM heating plate No. 3	250 x 250 x 2 L x W x H mm	1
558 0288	Aluminium contour plate, straight Suitable for: Thermopress EM heating plate No. 4	500 x 500 x 2 L x W x H mm	1
517 1900	Aluminium contour plate, straight Suitable for: Thermopress EM heating plate No. 5	800 x 625 x 2 L x W x H mm	1

VULCANIZING MACHINES AND ACCESSORIES

Thermopress accessories



Pressure equalizing pads - Thermopress

Ref. No.	Description	Size	Content	Qty			
517 1941	Set of pressure equalizing pads includes 1x Pressure equalizing pads car, 1x Pressure equalizing pads truck, 2x Alloy-heatingmat 210 x 140 mm		1	1	•	•	•
517 3853	Pressure equalizing pad car, size 0	110 x 110 L x W mm	1	1			•
517 2438	Pressure equalizing pad car, small	180 x 130 L x W mm	1	1			•
517 1989	Pressure equalizing pad truck, large	210 x 150 L x W mm	1	1		•	
517 1965	Pressure equalizing pad tractor, long	260 x 100 L x W mm	1	1	•		

Pressure equalizing pads - Thermopress

Ref. No.	Description	Size	Content	Qty		
517 0715	TP contour pad S2, red Suitable for: Sidewall	240 x 200 x 50 L x W x H mm	1	1	•	
517 0722	TP contour pad K3, red Suitable for: Tread	approx. 160 x 130 x 50 L x W x H mm	1	1	•	•
517 0739	TP contour pad S4, red Suitable for: Sidewall	approx. 180 x 160 x 35 L x W x H mm	1	1	•	•
517 0636	TP contour pad K1, red Suitable for: Tread	approx. 200 x 170 x 50 L x W x H mm	1	1	•	

VULCANIZING MACHINES AND ACCESSORIES

Thermopress accessories



Aluminium heating plate profile shapes, Thermopress

- For further use of the Thermopress vulcanizing machines
- For faster repairing and for the repairs which are not covered by the standard equipment
- The heat is distributed evenly due to the high thermal conductivity of aluminium

Ref. No.	Description	Size	Content	Qty				
517 3327	Sidewall pressure plate B3 Suitable for: Sidewall repairs trucks, 80-series	130 x 208 L x W mm	1	1	•			
517 3334	Sidewall pressure plate B4 Suitable for: Low-section tyres and sidewall repairs	approx. 100 x 160 L x W mm	1	1		•		
517 4003	Sidewall pressure plate 275/70 R 22.5 Suitable for: Sidewall repairs trucks, 70-series	210 x 115 L x W mm	1	1	•			
517 3365	Tread pressure plate Suitable for: Tread (inside)	200 x 130 L x W mm	1	1	•		•	•
517 3310	Aluminium heating plate profile shape, flat Suitable for: Tread (outside)	225 x 150 L x W mm	1	1			•	•
517 3963	Aluminium heating plate profile shape, contour Suitable for: Truck tyre tread (outside) and shoulder	230 x 150 L x W mm	1	1	•			
517 3970	Aluminium contour segment Suitable for: Aluminium heating plate profile shape; tyre tread (outside) and truck tyre shoulder	230 x 150 L x W mm	1	1	•			
517 3987	Aluminium heating plate cover Suitable for: Truck tyre shoulder	210 x 140 L x W mm	1	1	•			
517 7158	Heating plate attachment, top		1	1	•			
517 3451	Pressure plate D inside Suitable for: Truck tyre shoulder inside	195 x 103 x 35 L x W x H mm	1	1	•			
517 3461	Pressure plate E outside Suitable for: Truck tyre shoulder outside	180 x 120 x 39 L x W x H mm	1	1	•			
517 3452	Pressure plate G inside Suitable for: Truck tyre shoulder inside	195 x 103 x 38 L x W x H mm	1	1	•			
517 3462	Pressure plate H outside Suitable for: Truck tyre shoulder outside	180 x 120 x 35 L x W x H mm	1	1	•			

VULCANIZING MACHINES AND ACCESSORIES

1-step repair systems

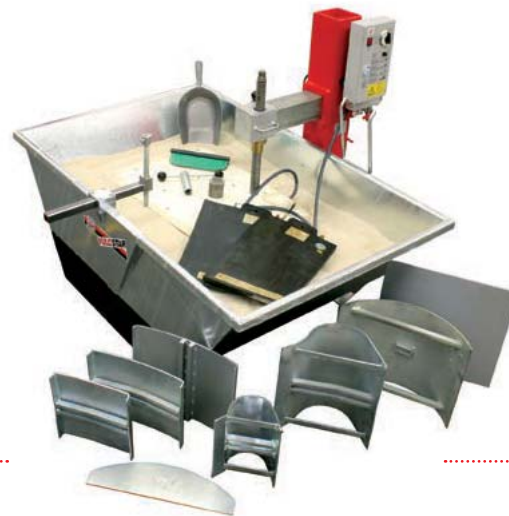

585 3003

VULCSTAR 900-S

- Can be used for 1-step repairs from SUV to agricultural tyres
- Repairs of any tread pattern or tyre profiles, all positions
- For patch sizes up to RAD 188 in a one-step process
- Little rework required for the repair of tread lugs
- The use of pressure granules allows the machine to be adapted to suit every tyre contour and makes finishing work easy
- Pneumatic vibrator for compacting the granules
- No tyre deformation during the curing process

* Optional accessories are available on request!

Scope of delivery:

- 585 3049 1 Control unit and granule heating
- 585 3460 1 Spindle adapter set
- 585 3470 1 Adapter
- 517 6939 1 AIR POWER BAG IV (470 x 300 mm)
- 517 6757 1 AIR POWER BAG VI (400 x 470 mm)
- 585 3063 1 Pressure block L2 (270 x 250 mm)
- 585 3070 1 Pressure block L3 (320 x 270 mm)
- 585 3094 1 Pressure block S2 (250 x 200 mm)
- 585 3104 1 Pressure block S3 (360 x 310 mm)
- 585 3095 1 Pressure block AS2

Operating voltage (V):

- Heating element for pressure granules: 2.2 kW/230 V
- Inner heating mat*: max. 0.4 kW/230 V



Operating temperature:

- Heating element for granules: 190 °C +/- 10 °C
- Inner heating mat*: 130 °C +/- 10 °C

Operating pressure (bar):

- AIR POWER BAG II* + IV: 3.0 bar
- AIR POWER BAG VI: 2.5 bar

- 585 3135 1 Pressure plate AS1 (460 x 350 mm)
- 585 3136 1 Pressure plate AS2 (390 x 450 x 2 mm)
- 585 3111 1 Counter-pressure plate GD1 (380 x 80 mm)
- 585 3128 1 Counter-pressure plate GD2 (250 x 130 mm)
- 585 7825 1 Tubular socket wrench
- 585 3550 4 Bucket for granules (22 litres)
- 585 3032 1 palette for pressure granules (14 x 25 kg)
- 585 3540 1 Shovel for granules (3000 ccm)
- 585 3166 1 Spatula for pressure granules
- 540 0052 4 Rubber pads (100 x 100 mm)
- Rubber mats

Ref. No.	Description	Voltage	Size		
585 3003	VULCSTAR 900-S for wide agricultural tyres up to 570 mm (sidewall), up to 850 mm (tread) and super-single truck tyres	230 V	1600 x 1200 x 1100 W x D x H mm	•	•

VULCANIZING MACHINES AND ACCESSORIES

1-step repair systems

VULCSTAR Rubber track repair kit

- VULCSTAR Extension kit, specifically developed for the repair of rubber tracks

- Cut injuries as well as lug tear-outs can be repaired with this kit

Scope of delivery:

- 585 3510 1 Electronic control box for heating plate
- 585 3460 1 Spindle unit comprising plug-in adapter housing and pressure spindle
- 585 3470 1 Adapter
- 585 3500 1 Pressure plate (500 x 450 x 34 mm)
- 585 3480 1 Equalizing pad (500 x 450 x 25 mm)
- 585 3520 1 Silicone heater on stainless steel plate, 230 V
- 585 3490 1 Pressure plate (550 x 450 x 2 mm)
- 581 3670 1 Repair manual



585 2990

Ref. No.	Description	Content
585 2990	Rubber track repair kit Suitable for: VULCSTAR	1
525 2303	Metal Primer PR-500-1 Is applied to the previously cleaned metal surfaces of the rubber tracks	750 g
525 2310	Bonding Agent S-500-2 Is applied after the first coat of Metal Primer - This preparation improves adhesion to the metal parts of the tracks	750 g

VULCSTAR SPEED Inner heating

- Suitable for all tyre repairs with VULCSTAR 700-S and VULCSTAR 900-S
- Easy to use
- Reduces curing time by 50 %
- Curing time is controlled from VULCSTAR control box
- Low-voltage system (42 V)



- Temperature of heating mats set to 160 °C (320 °F)
- Inner heating mat size I up to RAD 145 TL/ RAD 539 TL in a one-step process
- Inner heating mat size III up to RAD 186 TL in a one-step process

Scope of delivery:

- 585 3620 1 Control unit 230 V (200 x 300 x 155 mm)
- 585 3630 1 Suspension with cotter lock
- 585 3017 1 Inner heating mat size I (approx. 200 x 380 x 5 mm)
- 585 3024 1 Inner heating mat size III (approx. 310 x 475 x 5 mm)
- 581 1170 1 User's manual
- 1 Connection cable



VULCSTAR SPEED Inner heating
585 3530

Ref. No.	Description	Size			
585 3530	VULCSTAR SPEED Inner heating Electric power/connection to control box via 6-pole threaded coupling connector, metal Suitable for: VULCSTAR	200 x 160 x 300 L x W x H mm	•	•	•



585 3017, 585 3024

VULCANIZING MACHINES AND ACCESSORIES

1-step repair systems



Accessories for
VULCSTAR



517 6757



585 3159



585 1807

Accessories - VULCSTAR

Ref. No.	Description	Size	Content	Qty
585 3049	Control unit and granule heating in exchange		1	1
585 3470	Spindle adapter with pressure spindle		1	
517 6946	AIR POWER BAG II	320 x 300 L x W mm	1	1
517 6939	AIR POWER BAG IV	470 x 300 L x W mm	1	1
517 6757	AIR POWER BAG VI	470 x 400 L x W mm	1	1
585 3018	Inner heating mat size II, 230/40 V/W	380 x 200 L x W mm	1	1
585 3025	Inner heating mat size IV, 230/70 V/W	475 x 310 L x W mm	1	1
585 3104	Pressure block S3	360 x 310 L x W mm	1	1
585 3135	Pressure block AS1	430 x 350 L x W mm	1	1
585 1807	Wrench, pneumatic		1	1
585 3159	Tyre support, medium		1	1
585 3056	Pressure block L1	270 x 180 L x W mm	1	1
585 3063	Pressure block L2	270 x 250 L x W mm	1	1
585 3070	Pressure block L3	320 x 270 L x W mm	1	1
585 3087	Pressure block S1	200 x 170 L x W mm	1	1
585 3094	Pressure block S2	250 x 200 L x W mm	1	1
585 3111	Counter-pressure plate GD1	380 x 80 L x W mm	1	1
585 3128	Counter-pressure plate GD2	450 x 130 L x W mm	1	1
585 7825	Socket wrench		1	1
585 3142	Pressure clamp		1	1
585 3032	Flexible pressure granules		25 kg	1
540 0052	Rubber pads	100 x 100 mm	4	1
585 3166	Spatula for granules		1	
585 3136	Pressure plate AS2	390 x 450 x 2 mm	1	1

VULCANIZING MACHINES AND ACCESSORIES

1-step repair systems



517 5080



517 5090



517 5100

Latex

Vulcanizing machines for 1-step repair of EM/OTR tyres.

- The repair patch and the filling of the puncture channel are vulcanized at the same time
- Particularly suited for large-scale repairs
- No deformation of the tyre due to exterior metal mold
- Stationary installed machines for tyres from 17.5 R 25 to 58/80 R 63

Ref. No.	Description	Electric power/ connection	Curing temperature
517 5080	Latex 50 OTR tyres from 17.5 R 25 to 45/65 R 45 and agricultural tyres up to 1050/50 R 32. Instruments are analogical/digital.	230/380 V	150° C/302° F
517 5090	Latex 14-24 OTR tyres from 13.00 R 24 to 45/65 R 45 and agricultural tyres up to 1050/50 R 32. All data is available on a touch screen. Monitor in 4 languages.	230/380 V	150° C/302° F
517 5100	Latex 25-63 OTR tyres from 20.5 R 25 to 58/80 R 63. All data is available on a touch screen. Monitor in 8 languages. With hydraulic system.	380 V	150° C/302° F

VULCANIZING MACHINES AND ACCESSORIES

1-step repair systems



517 4290

BVS bead heating clamp

- Special bead heating clamp for stationary wall mounting
- Tyre is fixed inside the clamp
- Fast changing of tyres in industrial application
- Hardly any post-treatment of the repair location necessary

Ref. No.	Description	Electric power/connection	Operating pressure	Curing temperature	
In development	BVS Industry				•

Bead vulcanizing gripper BVS

- For rubber repairs at truck-tire-beads (19.5 to 24")
- Space-saving construction finds a place in every workshop
- Fixed temperatur, stiff segments with good distribution of the heat
- Nearly no buffing work necessary at the repaired area

Ref. No.	Description	Electric power/connection	Operating pressure	Curing temperature	
517 4290	Bead vulcanizing gripper BVS	230 V	mechanic	approx. 145° C (293° F)	•

VULCANIZING MACHINES AND ACCESSORIES

Equipment for working places



EM repair stand

For easy handling of EM tyres during the repair process. Speeds up the positioning of the tyre in the EM machine and improves safety at work.

Ref. No.	517 3554	517 4254	517 7811
Electric power/ connection		230/50 V/Hz	380/50 V/Hz
Loading capacity	600 kg	1000 kg	4000 kg
Size	1155 x 1280 x 2000 L x W x H mm	1150 x 1280 x 2200 L x W x H mm	2000 x 2000 x 2600 W x D x H mm
Weight	213 kg	250 kg	1200 kg
Tyre size	max. 29.5 R 29 Inch	max. 29.5 R 29 Inch	max. 33.25 R 35 - 48/95 R 57 Inch

Ref. No.	Description	Content	Qty		
517 3554	EM repair stand, with hoisting winch (manual) Total access to the tyre - Working height of the tyre is adjusted by specially geared hand crank - The roller bars allow easy rotation to the desired position and eliminate the risk of damage to the bead area - Castors enable convenient movement Suitable for: Thermopress EM I; Thermopress EM II	1	1	•	•
517 4254	EM repair stand, with hoisting winch (electric) Provides total access to the tyre - Working height of the tyre is adjusted by specially geared hand crank - Electric operation by means of a hand-held controller - The rollers on which the tyre rests allow easy rotation to the desired position and eliminate the risk of damage to the bead area - Castors enable convenient movement Suitable for: Thermopress EM I; Thermopress EM II	1	1	•	•
517 7811	EM repair stand, electrically operated Designed for the handling of large tyres - The tyre is lifted by a powerful hydraulic system - The rollers on which the tyre is positioned are driven electrically - Configuration for tyres also for 63" available on request Suitable for: Thermopress EM III	1	1	•	•

VULCANIZING MACHINES AND ACCESSORIES

Equipment for working places

REMA TIP TOP workplace PROFI

- The ideal workbench for the tyre specialist, which makes it easy to keep things tidy
- Saves wasting time searching for tools
- Includes illumination, zinc-plated work surface, 4 shelves and 2 multiple tool holders, multiple socket with on/off switch



517 4508

Ref. No.	Description	Size	Content	Qty
517 4508	PROFI workplace	1500 x 750 x 2200 W x D x H mm	1	1

Truck tyre working table

- Provides the optimum working conditions for professional truck tyre repair
- For ergonomic positioning of tyres up to 24"
- Table can be tilted and swivelled



517 1051

Ref. No.	Description	Content	Qty	
517 1051	Truck tyre working table	1	1	•

● VALVES, BALANCE WEIGHTS, ACCESSORIES
FOR TYRE AND WHEEL SERVICE, TPMS

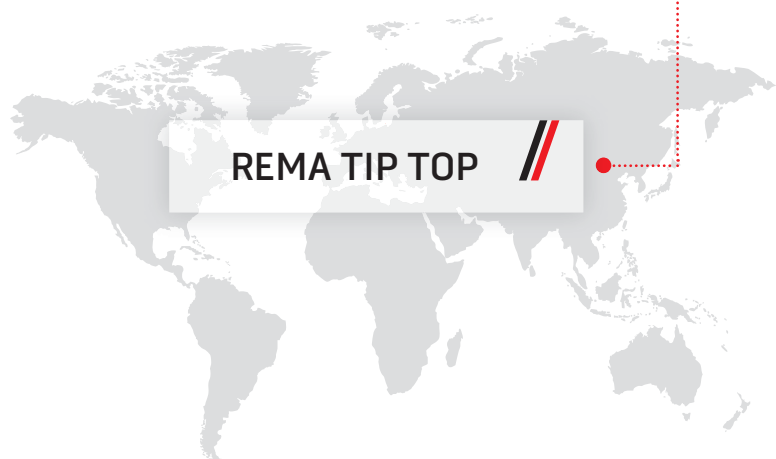

REMA TIP TOP



Valves	112
Balance weights	113
Accessories for tyre and wheel service	114
TPMS Tyre Pressure Monitoring Systems	115

VALVES, BALANCE WEIGHTS, ACCESSORIES FOR TYRE AND WHEEL SERVICE, TPMS
Valves



Snap-in valves



Metal valves



Metal valves truck, bus

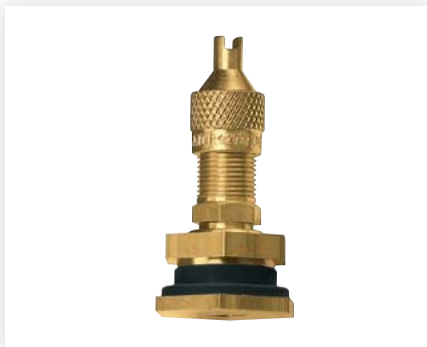

Metal valves EM



Tube valves



Valve extensions



Valve cores



Valve caps



Valve connectors

The broad range of REMA TIP TOP valves meets all requirements. It includes inner tube valves, valve extensions, valve caps and bleed nipples as well as connectors used in gas stations. The comprehensive array of sizes covers every area of use.

For detailed product information please view our online product catalogue at
→ <http://products.rema-tiptop.com> or contact your REMA TIP TOP country representation.
Our REMA TIP TOP Tool Catalogue presents many more tools.
Available online: at the media center, on our website: → <http://www.rema-tiptop.com>.

VALVES, BALANCE WEIGHTS, ACCESSORIES FOR TYRE AND WHEEL SERVICE, TPMS
Balance weights



Balance weights with clip,
car, light truck, motorcycle



Adhesive weights,
car, light truck, motorcycle



Adhesive weights, rolls



Balance weights,
truck, bus



Adhesive weights,
truck, bus



Granulat polymer
for balancing

REMA TIP TOP weights, manufactured to strict quality standards, are capable of handling even extreme loads and conditions. We offer our customers innovative balance, adhesive and spoke weights as well as granulat polymer and a large variety of corresponding accessories.

For detailed product information please view our online product catalogue at
→ <http://products.rema-tiptop.com> or contact your REMA TIP TOP country representation.
Our REMA TIP TOP Tool Catalogue presents many more tools.
Available online: at the media center, on our website: → <http://www.rema-tiptop.com>.

VALVES, BALANCE WEIGHTS, ACCESSORIES FOR TYRE AND WHEEL SERVICE, TPMS
Accessories for tyre and wheel service



REMAXX mounting paste



Tyre inflators



REMAXX EXive



Balance weight pliers



Balance weight remover



Valve lever



Valve mounting tools



Valve core screwdriver



CHECKPOINT indicators

Larger wheel diameters, smaller tyre cross-sections and more and more complex vehicles require that increasingly more attention is paid to valves and weights. Profit from our comprehensive product portfolio of accessories for tyre and wheel service.

For detailed product information please view our online product catalogue at
→ <http://products.rema-tiptop.com> or contact your REMA TIP TOP country representation.
Our REMA TIP TOP Tool Catalogue presents many more tools.
Available online: at the media center, on our website: → <http://www.rema-tiptop.com>.

VALVES, BALANCE WEIGHTS, ACCESSORIES FOR TYRE AND WHEEL SERVICE, TPMS TPMS Tyre Pressure Monitoring Systems



Devices for diagnosis and programming



TPMS equipment accessories



Universal sensors



Sensors



Service kits

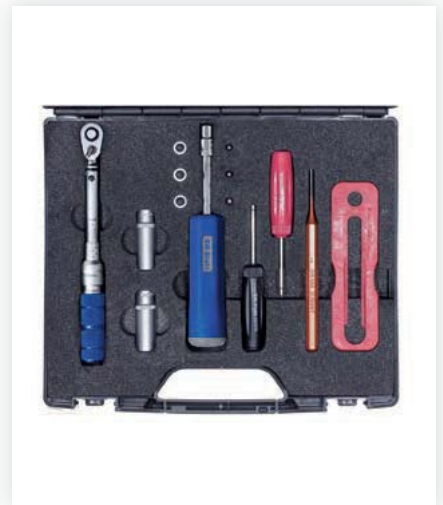

Special TPMS tools

Backed by over ten years of experience, REMA TIP TOP is a top source when it comes to TPMS system solutions with a comprehensive product portfolio including universal sensors, OEM replacement sensors, the required service kits, diagnostic and programming tools and special TPMS hand tools.

Additional relevant information, our comprehensive TPMS portfolio and our Sensor Selection Configurator can be found at → www.tpms.rema-tiptop.com



● CHEMICAL PRODUCTS, SAFETY AT WORK

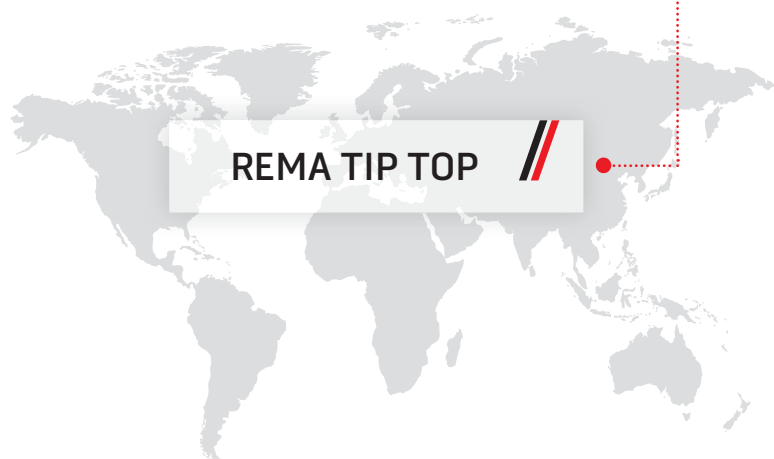

REMA TIP TOP



Protecting, cleaning and caring - Cosmetics

118-121

Mounting/Demounting/Pastes/Fluids

122-127

Personal Protection Products

128





593 2276



593 2269



593 2490



593 2252



593 2255

Hand protection

- SKIN PROTECT is a water-soluble, white, non-greasy and silicone-free skin cream which protects the skin with an elastic, non-slippery film
- Skin protection products help prevent damage to the skin by creating a „protective barrier“
- Protects against heavy soiling from substances such as soot, tar, adhesives, solvents, paint thinners etc.
- For use when carrying out tyre repairs or working on vehicles
- The slightly perfumed skin cream facilitates skin cleaning after work

Ref. No.	Description	Content	Qty
593 2276	SKIN PROTECT	1000 ml flexible bottle	1
570 9420	CLEANI skin protector	700 ml can	6
570 9050	STOKOLAN hand protection cream, silicone-free	100 ml standing tube	1
593 2490	Wall-mounted dispenser UNI 2000 for 2000 ml flexible bottles	1	1
593 2269	SILK SKIN skin care, after washing the hands	1000 ml flexible bottle	1

CLEAN-UP

- REMA TIP TOP CLEAN-UP is the cleaning paste to go
- Quickly removes even tough soiling from the hands without water - and is mild and gentle to the skin
- Simply put on your hands and dry-rub off

Ref. No.	Description	Content	Qty
593 2252	CLEAN-UP	25 ml tube	1
593 2255	CLEAN-UP, counter display	20 x 25 ml tubes	1



593 2150



593 2120



593 2570



593 0498



593 0450

Hand Cleaner FLUID

Hygienic packed hand cleaner, pumpable
 • Gentle and powerful

- Ready for use
- For all washrooms of workshops

Ref. No.	Description	Content	Qty
593 2150	HCL FLUID	250 ml tube	12
593 2110	HCL FLUID	2 l standing botte	1
593 2120	HCL FLUID	2 l flexible bottle	1
593 2570	Pump dispenser for 593 2110	1	1
593 2490	Wall-mounted dispenser for 593 2120	1	1

Hand Cleaner SOFT

• Contains vegetable oils
 • Without additional solvents
 • Extremely mild and gentle to the skin
 • Does not clog drains or outlets

- Alkali-free and adapted to the pH of the skin
- Extremely economical (approx. 2 grams are enough)

Ref. No.	Description	Content	Qty
593 0498	Hand Cleaner SOFT	500 ml plastic tin	12
593 0450	Hand Cleaner SOFT	11 l bucket	1



593 0481



593 0443



593 2018

Hand Cleaner SUPER

- High-quality raw materials for thorough removal of soot, paint, printing ink, tar, bitumen, underseal etc. without damaging the skin
- Dermatologically tested
- Easy to rinse off
- Contains micro scouring beads for cleaning down to the pores
- 100% sand-free, therefore will not clog drains or outlets
- Adapted to the skin's protective layer and alkali-free
- Effective cleaner formulated without organic solvents such as benzene
- Economical in use

Ref. No.	Description	Content	Qty
593 0481	Hand Cleaner SUPER	4 l bucket	1
593 0443	Hand Cleaner SUPER	11 l bucket	1
593 0436	Hand Cleaner SUPER	120 l barrel	1
593 0467	Hand Cleaner dispenser, 1000 ml	1	1
593 0160	Spare lid for Hand Cleaner dispenser	1	1

Hand Cleaner TOP CLEAN

- Efficient, cream formula hand cleaner which does not attack the skin
- Removes toughest soiling such as oil, grease, resin, paint etc.
- Cleans with mild ingredients and very fine abrasive materials with no organic solvents
- Contains no sand and therefore does not clog outlets or drains
- Over 90 % of the ingredients are biodegradable

Ref. No.	Description	Content	Qty
593 2056	Hand Cleaner TOP CLEAN	800 g	1
593 2018	Hand Cleaner TOP CLEAN	5 l bucket	1
593 2025	Hand Cleaner TOP CLEAN	10 l bucket	1
593 2063	Pump dispenser with wall mount bracket, 1250 ml	1	1



593 2537



593 0412



593 0467



593 2063

Accessories - Hand care, protection and cleaning

- Sturdy wall-mounted dispenser
- All Hand Cleaner dispensers are easy to re-fill
- Dispensing quantity is adjustable

Ref. No.	Description	Size	Content	Qty
593 2537	Wall-mounted dispenser, 1000 ml for REMA TIP TOP cream soap	380 x 130 x 170 H x W x L mm	1	1
593 0412	Hand Cleaner dispenser with wall mount bracket, 2500 ml Dispenses approx. 300 portions universally for all pastes	340 x 150 x 150 H x W x L mm	1	1
593 0467	Hand Cleaner dispenser, 1000 ml for Hand Cleaner SUPER		1	1
593 2490	Wall-mounted dispenser UNI 2000 for 2000 ml flexible bottles	290 x 125 x 125 H x W x L mm	1	1
593 2063	Pump dispenser with wall mount bracket, 1250 ml for Hand Cleaner TOP CLEAN		1	1

CHEMICAL PRODUCTS, SAFETY AT WORK

Mounting/Demounting/Pastes/Fluids



593 0632



593 0577



593 1332

REMAXX UNIVERSAL

- Approved by MERCEDES-BENZ (trucks) and PORSCHE
- For fast, gentle and easy fitting and demounting of all standard tyre/rim combinations
- Chemically neutral with respect to rubber and metal
- Excellent lubrication for mounting and demounting operations = fewer injuries
- Promotes adhesion between rim and tyre, prevents tyre slippage
- Non-spattering

Ref. No.	Description	Content	Qty						
593 0591	REMAXX UNIVERSAL	1 kg bucket	1	•	•	•	•	•	•
593 0601	REMAXX UNIVERSAL	3.5 kg bucket	1	•	•	•	•	•	•
593 0632	REMAXX UNIVERSAL	5 kg bucket	1	•	•	•	•	•	•
593 0625	REMAXX UNIVERSAL	10 kg bucket	1	•	•	•	•	•	•
593 1765	REMAXX UNIVERSAL, black	5 kg bucket	1	•	•	•	•	•	•

REMAXX SPORT

- Facilitates mounting and demounting of extremely wide tyres on all tyre changers
- Increased lubrication at the beginning of the mounting operation
- Fast-drying and non-spattering

Ref. No.	Description	Content	Qty		
593 0577	REMAXX SPORT	3.5 kg bucket	1	•	•

REMAXX MONTSEAL

- Durably seals minor leaks where the bead is seated on the rim
- Proven tyre mounting paste with additional bead sealing properties
- Ideal for mounting retreads or tyres on old rims

Ref. No.	Description	Content	Qty						
593 1332	REMAXX MONTSEAL	5 kg bucket	1	•	•	•	•	•	•

CHEMICAL PRODUCTS, SAFETY AT WORK Mounting/Demounting/Pastes/Fluids



593 0515



593 0508



593 0539

REMAXX TRUCK

- Developed for long sliding distances with high friction between tyres and rims, extreme mounting conditions etc.
- Effective sliding coat
- Makes tyre mounting/demounting easier, thus reducing wear to the equipment

- Chemically neutral to rubber, steel and aluminium
- Economic usage

Caution: Due to the high sliding effect not to be used for car or motorcycle tyres, tractor driving wheels, industrial or EM tyres with hose!

Ref. No.	Description	Content	Qty			
593 0515	REMAXX TRUCK	5 kg bucket	1	•	•	•
593 0522	REMAXX TRUCK	10 kg bucket	1	•	•	•

REMAXX CREME-W

- Higher viscosity combining the properties of a paste and a cream

- Application to the side wall of SE tyres ensures the turn-up effect

Ref. No.	Description	Content	Qty			
593 0508	REMAXX CREME-W	5 kg bucket	1	•	•	•

REMAXX CREME W-EM

- Mounting cream for large EM tyres
- Cream-type viscosity allows quick application to large areas

- Good mounting/demounting properties, stable viscosity

Ref. No.	Description	Content	Qty			
593 0539	REMAXX CREME W-EM	5 kg bucket	1	•	•	•

CHEMICAL PRODUCTS, SAFETY AT WORK Mounting/Demounting/Pastes/Fluids



593 0553



593 1851



595 8360



593 0584



593 0618



593 1978

REMAXX WAX-H

- For all standard mounting applications on two-wheel vehicle and car tyres
- Becomes transparent when dry

Ref. No.	Description	Content	Qty		
593 0553	REMAXX WAX-H	5 kg bucket	1	•	•

REMAXX MONT 2000

- For all standard mounting applications to car and truck tyres
- Cost-effective for big order quantities

Ref. No.	Description	Content	Qty		
593 1851	REMAXX MONT 2000	5 kg bucket	1	•	•
593 1875	REMAXX MONT 2000	10 kg bucket	1	•	•

Mounting paste brushes

- The flat brush is especially suitable for mounting low-profile tyres
- Brushes with round head are excellent for application of mounting cream

Ref. No.	Description	Dia.	Length of handle	Width	Content	Qty
595 8360	Flat brush car		200 mm	50 mm	1	1
593 0584	Special brush car	30 mm	300 mm		1	1
593 0618	Special brush truck, short	50 mm	300 mm		1	1
593 1978	Special brush truck, long	50 mm	400 mm		1	1
593 1954	Brush head, round	30 mm			10	1
593 1961	Brush head, round	50 mm			1	1

CHEMICAL PRODUCTS, SAFETY AT WORK Mounting/Demounting/Pastes/Fluids



593 5640



593 5630



593 5541



593 5510

REMAXX FLUID

- Specially formulated for reliable and clean mounting of premium low-profile tyres and modern wheel systems such as PAX, RFT, SST and UHP (Ultra High Performance)
- Sprayable solution with high initial sliding effect which reduces the seating pressure
- Dries quickly, ensuring that the tyre is safely seated on the rim
- Reduces the risk of clogging pressure sensors on the wheel
- Economic usage, not harmful to the environment
- Transparent fluid, dries without leaving visible residues on tyre or wheel
- 593 5660 for lubricating the mounting process of snap-in valves

Ref. No.	Description	Content	Qty	
593 5660	REMAXX FLUID	50 ml bottle with sponge	10	•
593 5640	REMAXX FLUID	400 ml spray	12	•
593 5630	REMAXX FLUID, sprayable	5 l can	1	•

REMAXX Demounting-Fluid

- Demounting-Fluid with excellent flow properties for demounting tyres which are stuck on their rims
 - Demounted tyre stays completely serviceable; wipe off the Demounting-Fluid after demounting
 - REMA TIP TOP Demounting-Fluid does not attack the rubber structure of the beads
 - Free from mineral oil
- Caution: Because of its high lubricating effect, Demounting-Fluid must not be used for mounting purposes. The tyre may slip off the rim when rolling!**

Ref. No.	Description	Content	Qty			
593 5541	REMAXX Demounting-Fluid	5 l can	1	•	•	•
593 5558	REMAXX Demounting-Fluid	10 l can	1	•	•	•
593 5565	REMAXX Demounting-Fluid	25 l can	1	•	•	•

REMAXX LUBE LIQUID

Liquid mounting agent, especially for agricultural tyres. **Caution: Concentrate to be diluted with water at a ratio of 1:5!**

Ref. No.	Description	Content	Qty	
593 5503	REMAXX LUBE LIQUID	1 l bottle	1	•
593 5510	REMAXX LUBE LIQUID	5 l can	1	•

CHEMICAL PRODUCTS, SAFETY AT WORK
Mounting/Demounting/Pastes/Fluids



593 0072



593 0388



593 0807



593 0814

REMAXX ANTI-GLISS LUBE

- Bead bonding agent on resin base
- Applied with a brush to the cleaned rim seat and tyre bead before mounting
- Do not additionally use a mounting agent such as mounting paste or mounting fluid
- The tyre is then mounted within up to 30 minutes before REMAXX ANTI-GLISS LUBE dries, leaving a viscous bonding coat

Ref. No.	Description	Content	Qty	
593 0072	REMAXX ANTI-GLISS LUBE	500 g tin	1	•

REMAXX LUBRICANT-SE

- Liquid lubricant for easy mounting of SE and SIT tyres
- Effective, long-lasting gliding film
- Reduces the pressure required to mount the tyre

Ref. No.	Description	Content	Qty	
593 0388	REMAXX LUBRICANT-SE	1 l bottle	1	•
593 5620	REMAXX LUBRICANT-SE	25 l can	1	•

REMAXX BEAD SEALER

- Spreadable sealant for sealing leaks caused by ageing or wear on the beads
 - Applied to the bead and bead seat before the tyre is inflated
 - During inflation the solid matter contained in the solution is pressed into the uneven areas and seals them
- Safety instruction:**
- As REMAXX BEAD SEALER is flammable, do not use it to fill the tyre
 - Also do not use it to seal larger bead injuries caused during tyre mounting, cuts extending to the fabric etc.

Ref. No.	Description	Content	Qty			
593 0807	REMAXX BEAD SEALER	1 l bottle	1	•	•	•
593 0814	REMAXX BEAD SEALER	5 l can	1	•	•	•

CHEMICAL PRODUCTS, SAFETY AT WORK Mounting/Demounting/Pastes/Fluids



593 5613



593 3990



593 0137



593 0145



570 9440

TYRE COMPOUND / REMAXX EXive

Ref. No.	Description	Content	Qty						
593 5613	TYRE COMPOUND Can be used as a „flexible pump ring“ for all tyre mounting operations - Stiff paste with stable viscosity to seal the gap between tyre bead and rim edge	10 kg bucket	1	•	•	•	•	•	•
593 3990	REMAXX EXive adhesive balance weight remover For removing residue left by adhesive weights	500 ml spray	1	•	•	•	•	•	•

Spray bottles

For even distribution of liquids on surfaces.

Ref. No.	Description	Content	Qty
593 0120	Spray bottle For applying liquid bead lubricant for industrial tyres etc. - Not suitable for solvents	650 ml	1
593 0137	Spray bottle Not suitable for solvents	1000 ml	1
593 0145	Spray bottle for compressed air, max. 6.2 bar Suitable for solvents - With nipple for compressed air supply - Can be used like a spray can	650 ml	1
570 9440	Pump spray bottle	1000 ml	1
593 0300	Set of spray nozzles includes 4x spray heads, 1x spray tube for 593 0144	4	1

Tyre care

Tyre paint

Can be painted or sprayed onto retreaded tyres to give the appearance of a new tyre.

Ref. No.	Description	Colour	Content	Qty
593 5084	REMA TIP TOP tyre paint, water-based	black	25 l metal bucket	1



Safety spectacles

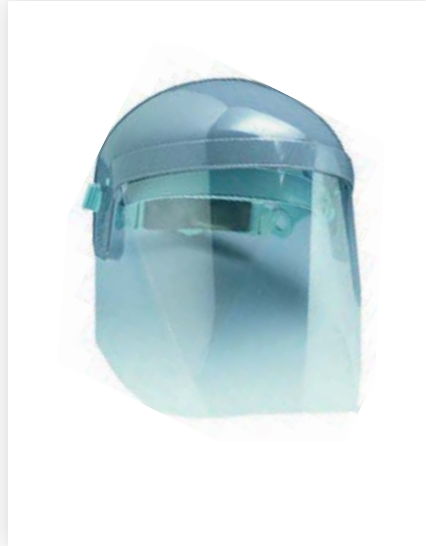

Face protector



Ear protection



Edge glove, cut resistant



Leather gloves



Working gloves

REMA TIP TOP is offering a selection of approved articles for your protection at the place of working.

For detailed product information please visit our online product catalogue at
→ <http://products.rema-tiptop.com> or contact your local REMA TIP TOP contact.

INDEX

A

Accessories - Hand care, protection and cleaning	121
Accessories - MINICOMBI	18
Accessories - RAS and SRAS	23
Accessories - RCF (Repairs Customer Friendly)	27
Accessories - SEALASTIC and SUPER SL	20
Accessories - SEALFIX	21
Accessories - Special buffing motors	72
Accessories - Thermopress EM	101
Accessories - Tyre marking	76
Accessories - VULCSTAR	106
Adhesive weights, car, light truck, motorcycle	113
Adhesive weights, rolls	113
Adhesive weights, truck, bus	113
Air buffers	68
Air buffers for retreading work	68
Aluminium heating plate profile shapes, Thermopress	103
Aluminium labels	77
Angle grinder	70
Arbours - adapters for quick release chuck type	61

B

Balance weight pliers	114
Balance weight remover	114
Balance weights with clip, car, light truck, motorcycle	113
Balance weights, truck, bus	113
Ball rasp, Silver class	53
Ball shaped chip rasps, Classic class	52
Bead breaker	90
Bead repair segments	63
Bead vulcanizing gripper BVS	108
Brushes for solutions	42
Buffing and grinding wheels	63
Buffing brushes	63
Buffing discs for angle grinders	55
Buffing rasps for retreading	63
Buffing wheels, Classic class	50

Buffing wheels, REMA TIP TOP class	55
BVS bead heating clamp	108

C

Carbide cutter	47
CEMENT FD-BL, free of CFC/aromatic compounds	34
CEMENT SC-BL, free of CFC/aromatic compounds	34
CHECKPOINT indicators	114
Chip cone rasp, Silver class	53
Chip cones, Classic class	48
CLEAN-UP	118
Cleaning brushes	66
Compass saw for steel cord tyres	46
CROSS-PLY repair patches, series PN	30
CROSS-PLY repair patches, series PN-OTR	31
Cutting knife for regroovers	81
Cutting tools	66

D

DETREADER blades for buffing machines	63
Devices for diagnosis and programming	115
Digital extension - Thermopress	95
Digital thermometer	67
Domed buffing rasps, Silver Class	53
Domed contour rasps, Classic class	51
Domed contour rasps, Gold class	54
Domed contour rasps, REMA TIP TOP class	54

E

Ear protection	128
EASY REPAIR GUM, free of CFC/aromatic compounds	64
Edge glove, cut resistant	128
EM bead breaker GIGANT I	89
EM bead breaker GIGANT II	89
EM bead breaker STANDARD	88
EM mounting set	88
EM repair stand	109

INDEX

Envelope patches	65	L	
Envelope release agent	64	Latex - Vulcanizing machines	107
Envelope sidewall plates	65	Leather gloves	128
Extruder COMPOUND MASTER	74	Lighting	82
Extruder GIANT	73	Limestones	57
Extruder NAILHOLE	74	LIQUID BUFFER	32
Extruder NORMAL	73		
		M	
F		M-RCF repair patches, series 400	27
Face protector	128	Marking with chalk	75
Finish buffer ES	59	Marking with pen	75
FIXPASTE VC4-A+B, free of CFC/aromatic compounds	39	Measuring tools	67
Flex drive arbours MK 1	62	Metal valves	112
Flexible shaft	70	Metal valves EM	112
Fret saw	70	Metal valves truck, bus	112
		Mini buffing tools, Silver class	52
G		MINICOMBI - Overview	15
Granulat polymer	113	MINICOMBI A3	16
Grinding tools for steel cord preparation	58	MINICOMBI A3/A6 SET	15
		MINICOMBI A4.5	16
H		MINICOMBI A6	17
Hand Cleaner FLUID	119	MINICOMBI A6/B8 SET	16
Hand Cleaner SOFT	119	MINICOMBI B10	18
Hand Cleaner SUPER	120	MINICOMBI B8	17
Hand Cleaner TOP CLEAN	120	Motorcycle repair kits TT 10	10
Hand drills	70	Mounting paste brushes	124
Hand protection	118	MTR cushion gum	38
Heat resistant gliding foil	40	MTR RUBBER	37
HSS mill cutters	48	MTR SUPER FINISH RUBBER	38
Hygrometer	67	MTR-CR RUBBER	38
I		O	
Impact wrenches	70	OTR SPECIAL CEMENT, free of CFC/aromatic compounds	35
Infrared radiation thermometer	67		
INNERLINER SEALER, free of CFC/aromatic compounds	36	P	
Jacob chuck type arbours	60	Patch hammer	69
		Pen piercing thermometer	67

INDEX

Pencil buffers, Classic class	49	Rotary gouges	46
PLUG SRAS-PROFI (SUPER RADIAL ANCHOR SEAL)	22	Rotary plastic brush	56
Pneumatic fret saws	69	Rotary wire brushes	56
Pressure compensation cloth	40	Rubber base valves	13
Pressure equalizing pads - Thermopress	102	Rubber base valves (hot vulcanization)	14
Preventive tyre sealant TT SEAL	8	RUBBER CUT 314	80
Profil depth gauge	67	RUBBER CUT 414	80
Pumps	91	RUBBER CUT STATION ECO	81
		Rubber knives	66
		RUN-FLAT	15
R		S	
RAD repair patches, series 100	24	Safety spectacles	128
RAD repair patches, series 100 - Preventive	26	Screwdriver	70
RAD repair patches, series 300 – STEEL	26	SEALASTIC	18
RAD repair patches, series 500 - ARAMID	28	SEALFIX GO-ON	20
RADIAL ANCHOR SEAL (RAS)	22	SEALFIX SHOP, workshop kit	21
Regroover	80	Sensors	115
REMA TIP TOP repair patch templates	41	Service kits	115
REMA TIP TOP workplace PROFI	110	Shore hardness tester Shore A	67
REMASTEM	23	Snap-in valves	112
REMAXX ANTI-GLISS LUBE	126	SOLUTION HR, free of CFC/aromatic compounds	35
REMAXX BEAD SEALER	126	SOLUTION MTR, free of CFC/aromatic compounds	35
REMAXX CREAM W-EM	123	SOLUTION T2, free of CFC/aromatic compounds	36
REMAXX CREAM-W	123	Spacers	63
REMAXX Demounting-Fluid	125	Special buffing motors	71
REMAXX EXive	114/127	Special TPMS tools	115
REMAXX FLUID	125	Spray bottles	127
REMAXX LUBE LIQUID	125	Stapler	69
REMAXX LUBRICANT-SE	126	Stitchers	66
REMAXX MONT 2000	124	SUPER SL TT 650	19
REMAXX MONTSEAL	122	SUPER SL TT 651	19
REMAXX mounting paste	114	Support stand - Thermopress	96
REMAXX SPORT	122	SV bonding rubber, blue	37
REMAXX TRUCK	123	SVS-VULC Vulcanizing fluid	33
REMAXX UNIVERSAL	122		
REMAXX WAX-H	124		
REP BOY tyre spreader	86		
REPMAT tyre spreader	86		

INDEX

T

T2-CL Cleaning rubber	40
T2-COMPOUND	39
Talc	43
Thermopress DUPLEX	94
Thermopress EM heating mats	100
Thermopress EM heating plate	100
Thermopress EM heating pockets	101
Thermopress EM I	97
Thermopress EM II	98
Thermopress EM III	99
Thermopress EM pressure-equalizing pads	101
Thermopress fast-curing repair patches	29
Thermopress TP II	95
Thermopress tyre repair kit	29
Tins with brushes	43
TPMS equipment accessories	115
Truck tyre working table	110
TT Cleaning Fluid R4, free of CFC/aromatic compounds	36
Tube patches, red edge	9
Tube valves	13/112
TYRE COMPOUND / REMAXX EXive	127
Tyre inflators	114
Tyre lift spreader RHS 300-2	87
Tyre marking, electric	76
Tyre paint	127
Tyre scrapers	66
Tyre sealant TT SEAL XXL	8
Tyre spreaders	84

U

UNIVERSAL PATCH (UP)	24
Universal sensors	115

V

Vacuum cleaner for dust/water	69
Valve caps	112

Valve connectors	112
Valve core screwdriver	114
Valve cores	112
Valve extensions	112
Valve lever	114
Valve mounting tools	114
Valve patches	14
Valve patches with fabric reinforcement	14
VULCSTAR 900-S	104
VULCSTAR Rubber track repair kit	105
VULCSTAR SPEED Inner heating	105

W

Wetstones	66
Working gloves	128
Working light Light-Master	83
Working light NOVA	82
Workshop kit TT 11	10
Workshop kit TT 12	10
Workshop kit TT 20	11
Workshop kit TT 21	11
Workshop kit TT 30	11
Workshop kit TT 40, tube	12
Workshop kit TT 42, tube	12